

# Art Sphere, Inc. Celebrating **LGBTQ+ Artistic Icons**

A coloring book for high school age youth

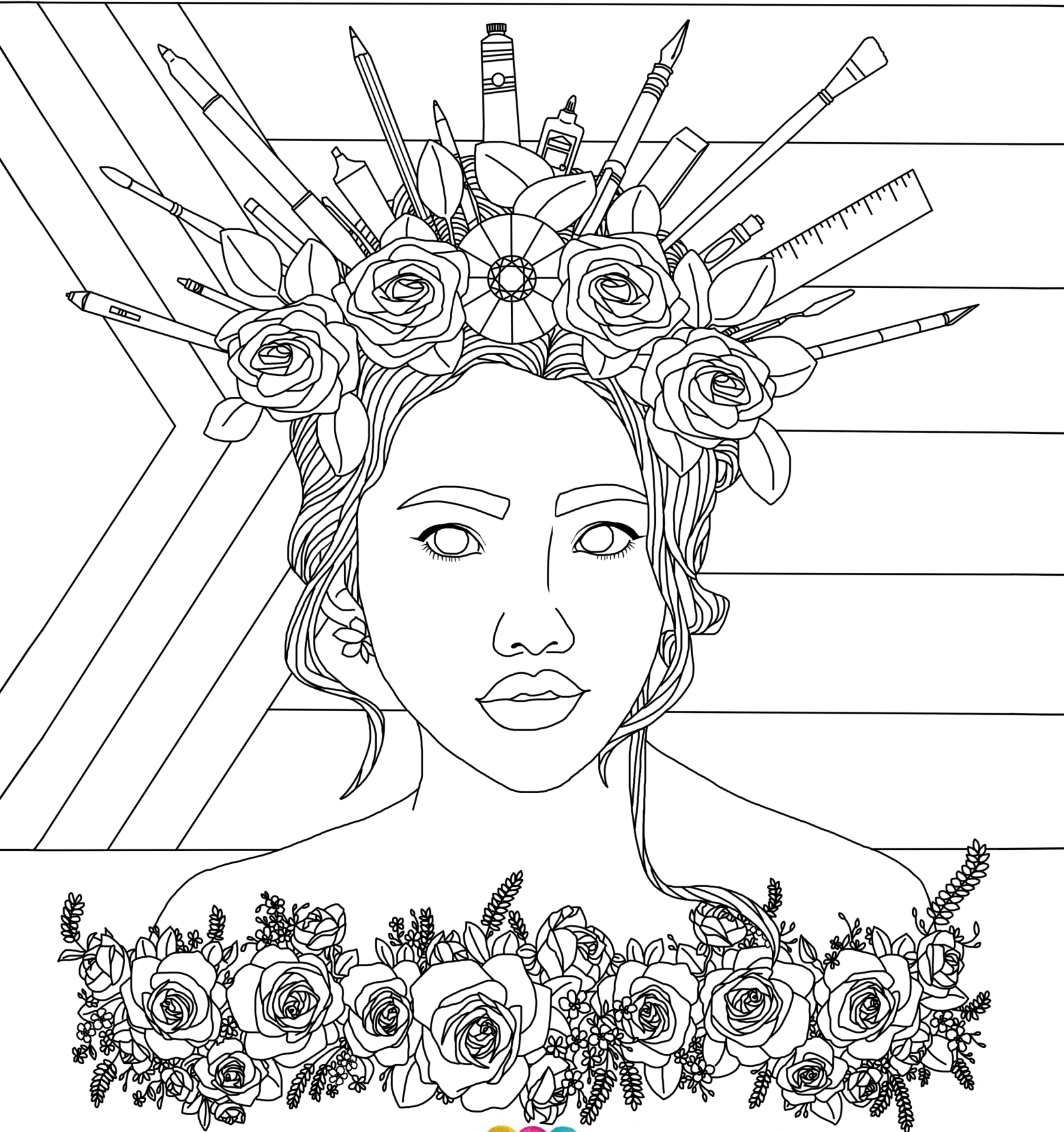

# TABLE OF CONTENTS

- i Preface
- 1 Color Theory
- 3 Pride Flag
- 4 Go Love Yourself
- 5 Isaac Julien
- 7 Julie Mehretu
- 9 Catherine Opie
- 11 Sylvester
- 13 Chavela Vargas
- 15 Mickalene Thomas
- 17 Paul Mpagi Sepuya
- 19 Harmony Hammond
- 21 Shanel Edwards
- 22 H.D.
- 23 Rivers Solomon
- 25 Laetitia Ky
- 26 Frank Ocean Shirt
- 27 Emerald City Wand
- 28 Share the Love Wand
- 29 Making A Crown
- 30 Grow Pride
- 31 Grow Pride Gardening Tags
- 32 Blackout Poetry
- 33 Keystone Architectural Symbol
- 34 Keystone State Symbol
- 35 Comic Strip
- 36 Diorama Making
- 37 Bookmaking





Art Sphere Inc.  
Transforming Lives Through Art

STRENGTHENING OUR COMMUNITIES SINCE 1998

BOK Building, 1901 S 9th St. Studio 502, Philadelphia PA, 19148 • (215) 413 -3955 • www.artsphere.org • info@artsphere.org

# CELEBRATING LGBTQ+ ARTISTIC ICONS

*A coloring & activity book for high school*

## Preface

We are pleased to present Art Sphere's coloring and activity book where we explore LGBTQ+ identity, art history, and color theory. You will learn about LGBTQ+ artists, as well as ways to express your pride any time of the year. Whether it's a pride flag or your own personal art, showing your true colors is important.

## How this Book Came About

In 2020, Art Sphere Inc. (ASI) responded to COVID-19 by moving our curriculums online to engage and enrich Philadelphia's communities remotely. ASI has always been concerned about the lack of access and cutbacks in funding for the cultural arts in the inner city. In response, we developed this book of free art lesson plans for children to stimulate and inspire creative thinking. What we hope you will gain from using this book Not everyone learns the same way. Some people are more visual, some more musical, some more mathematical. Our coloring sheets and activity guides give viewers an opportunity to make art in more than one way and also to incorporate ideas such as compassion, creativity, cooperation, and new ideas for living in a way that contributes to a civil society. By pointing out the different ways that a project can be approached, parents and teachers can guide their children to their individual paths to artistic success and ways to express their unique creative voices.

May you gain inspiration from these pages and reach toward the horizons of your creativity!

## About US

Art Sphere Inc. (ASI), founded in 1998, provides meaningful free arts programs in an effort to engage the creativity in communities, empower neighborhoods, explore the positives in peoples' lives, and heal the mind, body, and spirit through the arts. Working with hundreds of volunteers every year and partnering with numerous civic, academic and governmental organizations, our grassroots events help support inner-city neighborhoods. ASI's in-school and after-school workshops lay the framework for the arts to nourish the character and development of youth, open up a new world of social engagement and reinforce the school curriculum. We appreciate the generous support of the many foundations and institutions who have paved the way for Art Sphere Inc. to continue to serve the public through on-site and online education programs.



# THANK YOU

This book would not have been possible without the participation of many talented and dedicated volunteers and supporters. I would like to thank the Drexel University for their support, encouragement and for believing in Art Sphere's work with youth. My thanks also go to Judy Yellin, Hanna Pistorus and Steven White for their collaboration, editing of the lesson plans and invaluable suggestions. I also want to single out Claire Manigo-Bizzell for her hard work in creating the layout and design for this printable handout version of our "Celebrating LGBTQ+ artistic Icons" eBook, as well as Carey Talbot-Sanders, Sophie Najjar, and Ginger Mellott for their well-crafted cover design and hand-drawn elements that also can be found at <https://artsphere.org/asi-books/>. Many volunteers also provided their time and expertise for which I am very grateful:

**Administration Team:** Ana Paula Brito da Silva Bim, Mallika Kodavatiganti, Jessica Soriano, Hiral Parekh, Julia Fucci, Graeme Turner, Casey Raffle, Braeden Dinger, Mi Nguyen

**Social Media Team:** Jade Hingtgen, Martha Meiers, Kyle Kaempf, Digna Patel, Aiknoor Kaur, Hardwick Sexton

**Writer and Grant Writer Team:** Sarah Goldberg, Shalini Parekh, Kristyn Otto, Maura Mealy, Sam Oliviera, Julie Kim, Anthony Mazzocca, Courtney Lancaster, Maura Wynne, Benjamin Ruff, Julia Woch

**Designer Team:** McKenna Mason, Digna Patel, Simone Shemshedini, Blair Nakamoto, Jay Wahla, Kaili Chen, Addison Devine

**Teacher Team:** Yen Nguyen, Maritza Lohman, Jedidah Groseclose, Greta Heeb, Kristen Rucker, Theresa Oliver, Kristine Macatantan, Kelly Ramirez, Jasmine Oberoi, Shika Veera, Daniela Wittenberg, Christin Wade, Madison Hatchett, Jamie Sokol, Celia Tran, Natalie Perez

**Web Design Team:** Jennifer Granata, Kip Deeds, Hanae Ferahi, Mya Ho, Parker Nix, Nyemike Atoh, David Do, Hangyu Li, Tim Nguyen, Ebunoluawa Diya, Iain Shand, David Ajibade, Susie Choi, Wenjun Shao

**Video Team:** Miguel Geniza, Victoria Sanua, David Rammacca, Sabine Moufarrej, Nicole Harmon, Bryant Lu, Chase Levine, William Li, Aidan Perry, Kaitlyn Ha, Sean Kim, Liam Shea, Sophia Palmisano, Joey McQuillan, Maggie Bues

**Animation Team:** Kai Snowden, Roger Korpics

**IT Team:** Andrew Phillips, Rupali Walunj, Josh West, Timo Stander, Jineva Byrne, Michael Vranek, David DeBroux, Carlos Frias, Rabia Shafique, Asanka Nanayakkara, Fabio Martinez, Jasmine Campbell, Raudi Lantigua, Deonte Wynn, Praveen Lokanathan, Karthikeyan Nagarajan, Sunil Gopi

A special thank you to our Board of Directors as well: Erica Bettwy, P.J. Hakim, Subrata Mukherjee, Cliff Price John Groenveld, Tiffany Mercer-Robbins and Ashley Fry.

Best Wishes on Your Journey,

Kristin Groenveld  
Founder and Artistic Director Art Sphere Inc.

Check out our interactive program for more creative art projects and artist profiles: <https://artsphere.org/landing-page-lgbt/>

**Share the artwork you make and your thoughts about the lesson plans and let others know about our free online version of this book: #takeanartjourney #creatinglegaciesthroughart #loveartsphereinc**

# ARTIST BIOS

Janelle Monae is a musician, actress and activist who uses her platform as a form of self-expression. Monae identifies as bisexual and pansexual and has used her artforms and alter-ego to express her feelings on these matters among many other things.

Isaac Julien is a filmmaker and installation artist born in 1960 and is based in London. Isaac is a gay Black man, two pieces of his personal identity that he explores in his work among many other things.

Rivers Solomon uses fae/faer pronouns and identifies as nonbinary. Solomon is an American author of literary fiction whose debut novel was published in 2017.

Laetitia Ky is an Ivorian Coast model and artist who uses wires and her hair to make hair sculpture pieces that are meant to carry a message.

Julie Mehretu is an abstract artist from Ethiopia. Mehretu is believed to be one of the top-selling living lesbian artists, with her works reportedly selling to total \$21,729,529 at auction.

Catherine Opie is an American Fine Arts photographer that began taking pictures at the age of nine and eventually had her own darkroom at 14. Opie uses her camera to examine the connections between a mainstream and marginalized society.

Paul Mpagi Sepuya is an artist from Los Angeles, CA that explores queer and Black identity. Sepuya's photos sometimes include himself as the subject that feel quite intimate and personal.

Harmony Hammond is a queer female artist and activist who gained prominence in the 1970's for her outstanding work and determination. She was one of the creators of A.I.R., which was the first women's run art gallery where groups of artists could come together to show off and sell their work.

Born in Pakistan in 1983, Salman Toor is a gay painter and writer who's based in New York. In April of 2021, Toor closed out his first ever solo exhibit, which was on display at the Whitney museum in New York and was titled *How Will I Know*.

Shanel Edwards is a first generation Jamaican-American and identifies as nonbinary. They are most prominently a dancer, but they've also dabbled in painting, poetry, photography, and more.

The bisexual poet Hilda Doolittle was first published thanks to a friend she met in college who had sent in some poems to *Poetry* magazine under the name of H.D. which she took as a pen name. It wasn't until Doolittle had her first volume of verse published in 1916 that she was recognized as a major voice of the avant-garde imagist movement.

Assotto Saint (formerly, Yves François Lubin) was a gay Haitian born poet that fell in love with the United States

after a trip exposed him to men in feminine clothing. Saint was captivated by the freedom of the United States as compared to his native home, and eventually moved to the U.S. with his mother.

Alice Walker is a revered Pulitzer Prize winning author who has been a vocal advocate for people of all sexualities. Walker's literary career is filled with critically acclaimed gems like *The Color Purple*.

Cheyne Gallarde is a gay artist who was born and raised in Hawaii. Gallarde is best known for his works that depict drag queens as superheroes in the style of vintage comic books.

Mickalene Thomas is a renowned artist most notably known for her vibrant works that showcase Black women's power and femininity. Thomas uses mixed media art to explore forms of beauty outside of societal norms and draws inspiration from the Impressionist art movement.

Chavela Vargas is a legendary lesbian ranchera singer. Despite ranchera singing being a male dominated scene, Vargas broke barriers and soon became a household name.

Sylvester is a disco icon who never felt the need to be boxed into a label. During his lifetime, other people tried pinning him as a drag queen or as transgender when those identities were generally perceived in a more negative light than today, but Sylvester didn't pay attention to labels - he was just being himself.

Jay Som Melina Mae Duterte, better known by her stage name Jay Som, is a musician who writes about self-discovery, reflection and her racial identity. Duterte has said while she was growing up that she didn't really see people like her that she could look up to, so she has tried to become a role model for generations after her.

Patrick Kelly is a fashion designer that wanted to make clothes for Black women so they could be in *Vogue* magazine. After moving several times, Kelly ended up in France where he was able to find fame as a fashion designer.

Richard Fung is a Canadian writer, video artist and professor. He is openly gay and has spoken out about sexual orientation and has created many videos that deal with Asian Colonialism, immigration, racism, homophobia, AIDS, justice in Israel/Palestine and his own family history.

# Color Theory

While we might take it for granted sometimes, colors are an important part of everyone's life! When you choose something to wear, decorate a room or pick crayons to color a handout, you are instinctively working with a color scheme.

Did you know there is the theory for choosing colors that complement each other? It is called the color wheel. The color wheel is made up of three kinds of colors – primary colors, secondary colors, and tertiary colors. Primary colors occur by themselves, secondary colors occur from a mixture of two primary colors, and tertiary colors occur from mixtures of primary and secondary colors. A color scheme is a combination of colors you choose. You can make a color scheme by following patterns in the color wheel. Four of these patterns are:

**Analogous:** Colors next to each other on the wheel.

**Triadic:** Three colors evenly spaced on the wheel.

**Complementary:** Two colors opposite of each other on the wheel. Primary and secondary colors are complementary to each other and tertiary colors are complementary to each other too.

**Split complementary:** Uses three colors. Find one color, then find that color's complement. Then use the two colors on either side of that complementary color.

# Color Theory

Fill in the color wheel with the appropriate colors labeled below. Mix different primary and secondary colors to fill the spaces in between the labeled spaces.

Below the color wheel, fill in the smaller slices with the same orientation of colors to show off analogous, triadic, complimentary, and split complimentary color schemes.

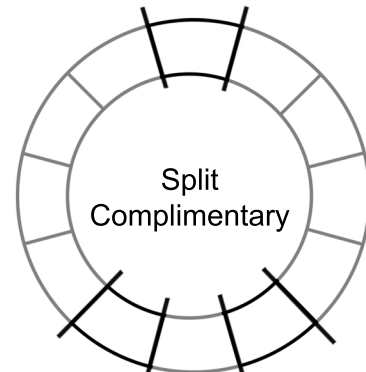
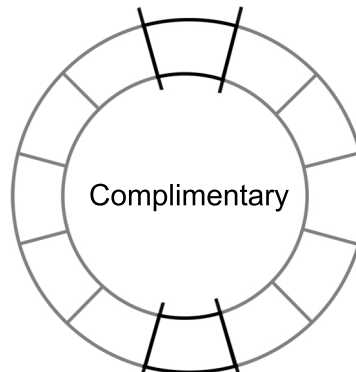
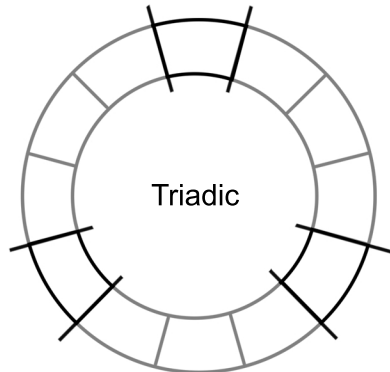
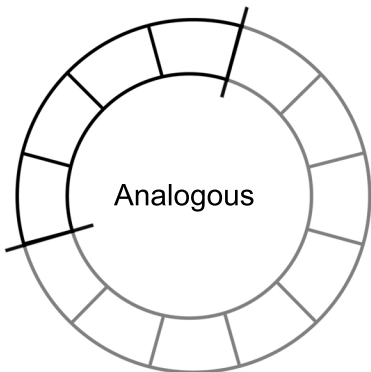
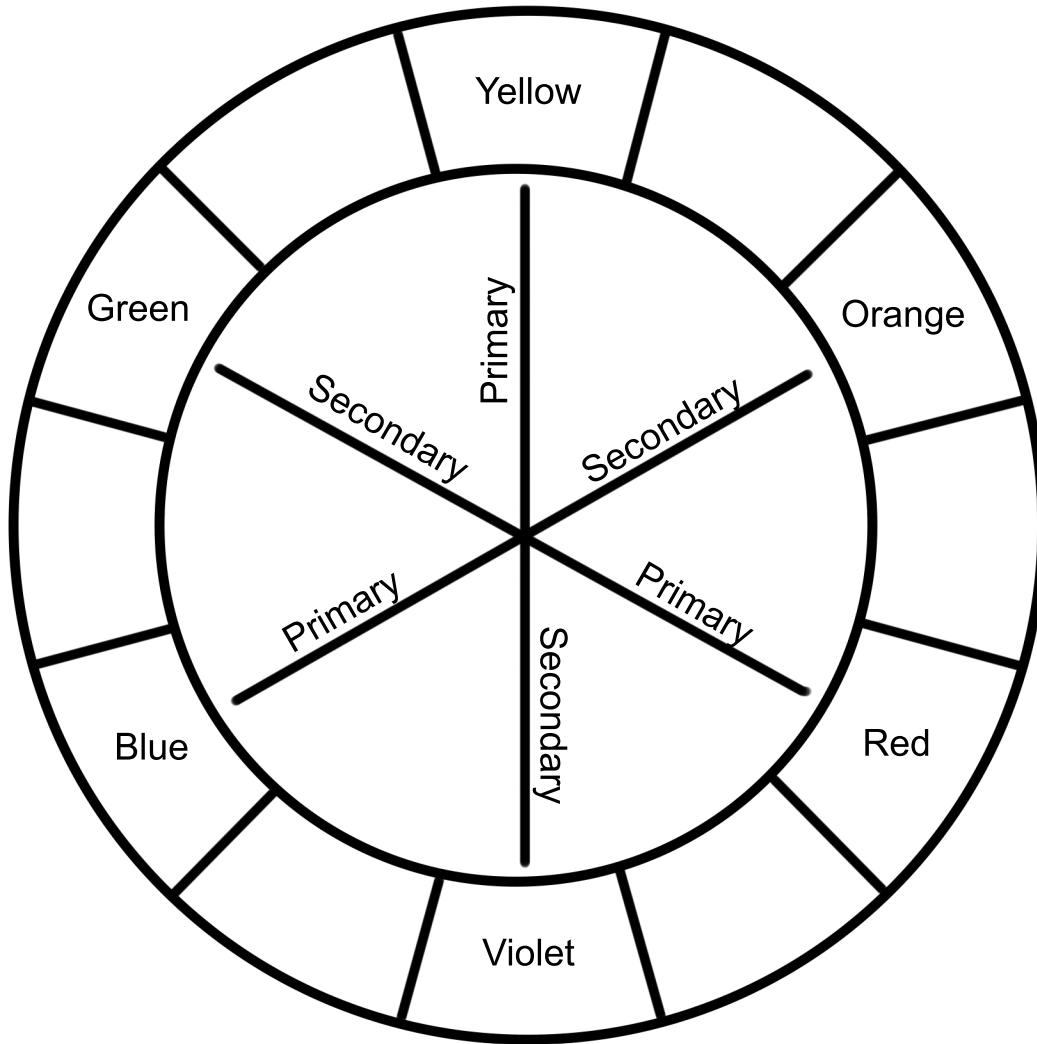

# Happy Pride Month

The rainbow flag (also known as the gay pride flag or LGBT pride flag) is a symbol of lesbian, gay, bisexual, transgender, and queer (LGBTQ) pride as well as LGBTQ social movements. The colors reflect the diversity of the LGBTQ community, as the flag is often used as a symbol of gay pride during LGBTQ rights marches. The black and brown stripes are an inclusionary way to highlight black and brown LGBTQIA members.

**Celebrate the month by making a Pride flag Popsicle stick.**



## Pride Flag Popsicle stick Instruction

1. Cut along the dotted lines.
2. Use glue to attach to the flag.
3. Celebrate with your pride flag!

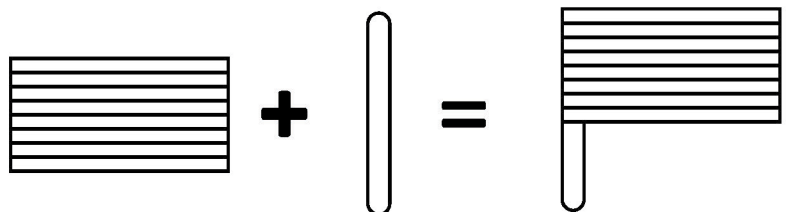



GO

LOVE

YOURSELF

# Isaac Julien

Isaac Julien is a filmmaker and artist from London, England whose work explores Black identity, sexuality, class, art history, and culture. In addition to his work as a documentarian, he creates multi-screen installations of unique film footage and photographs. Inspired by Julien's work, create your own three screen installation! What would you pair together to make a unique, immersive watching experience? Illustrate or write your ideas on the panels provided on the second page.

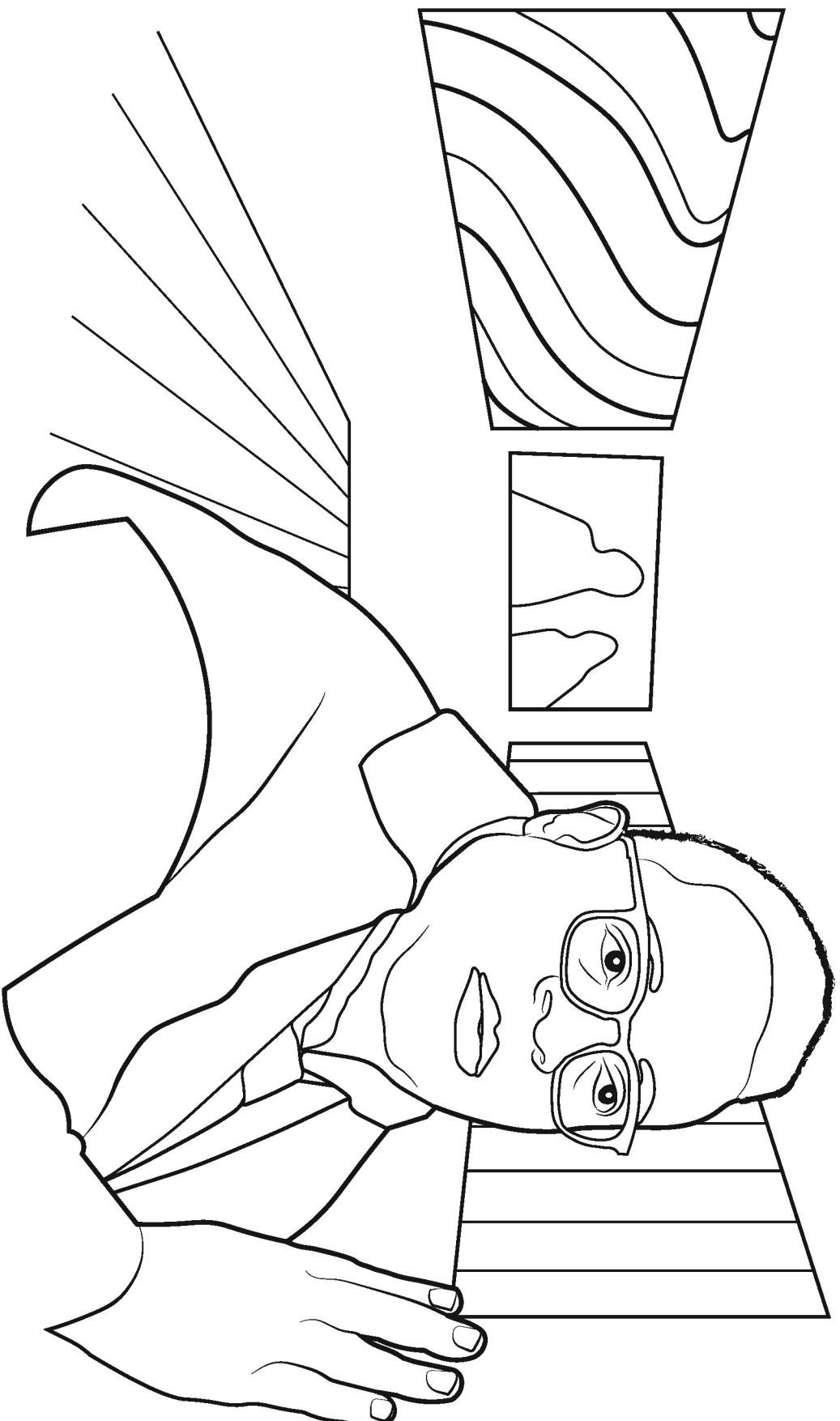

Sketch out your ideas for your own installation here!

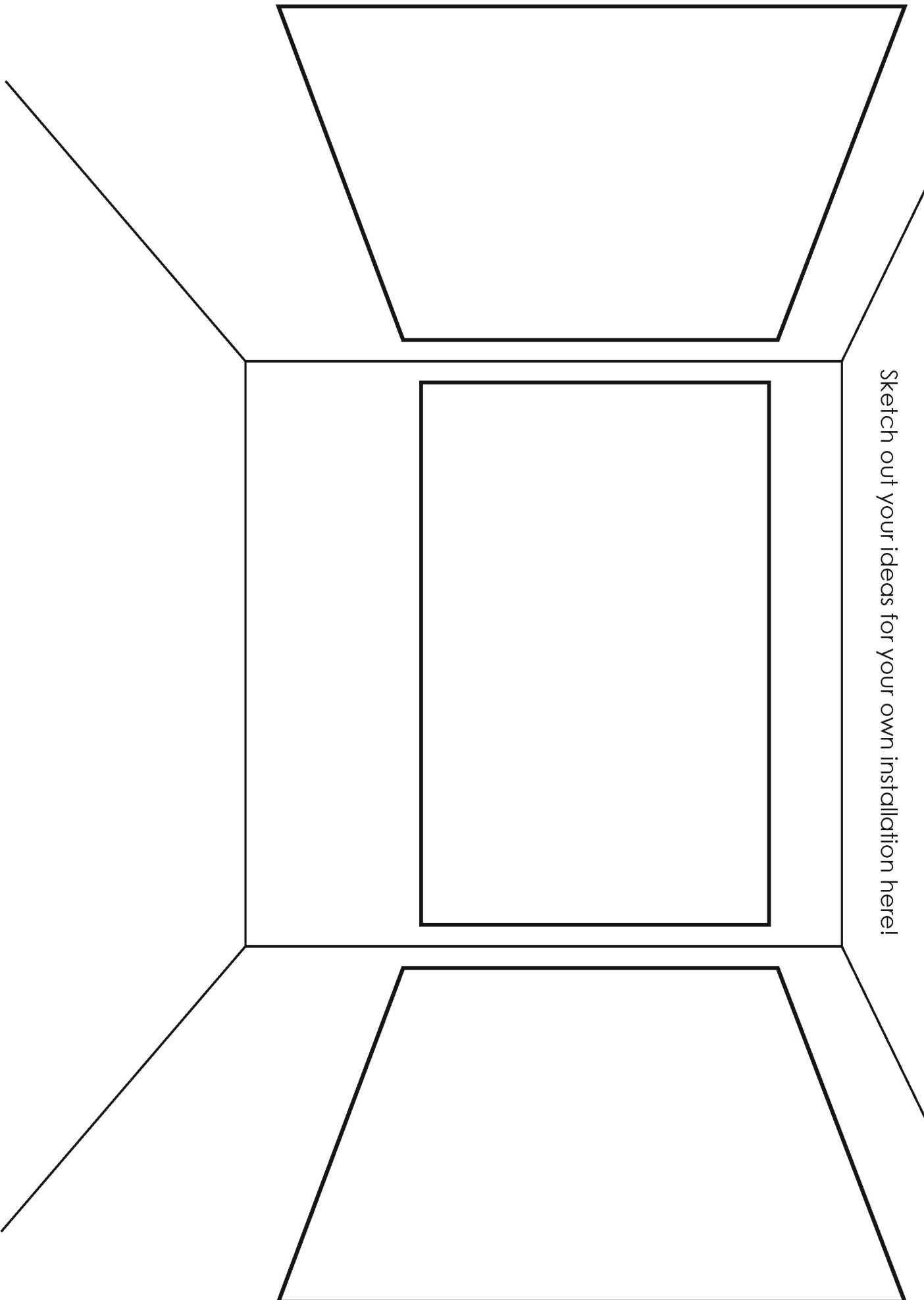

# Julie Mehretu

Born in Addis Ababa, Ethiopia in 1970, Julie Mehretu is an American artist known for her large, layered, and elaborate paintings. Her paintings consist both of abstract elements (shapes and brushstrokes), as well as representational references to architecture and art history. Her work is currently on display as part of a mid-career retrospective at the Whitney Museum of American Art in New York City (March 25-August 8, 2021).

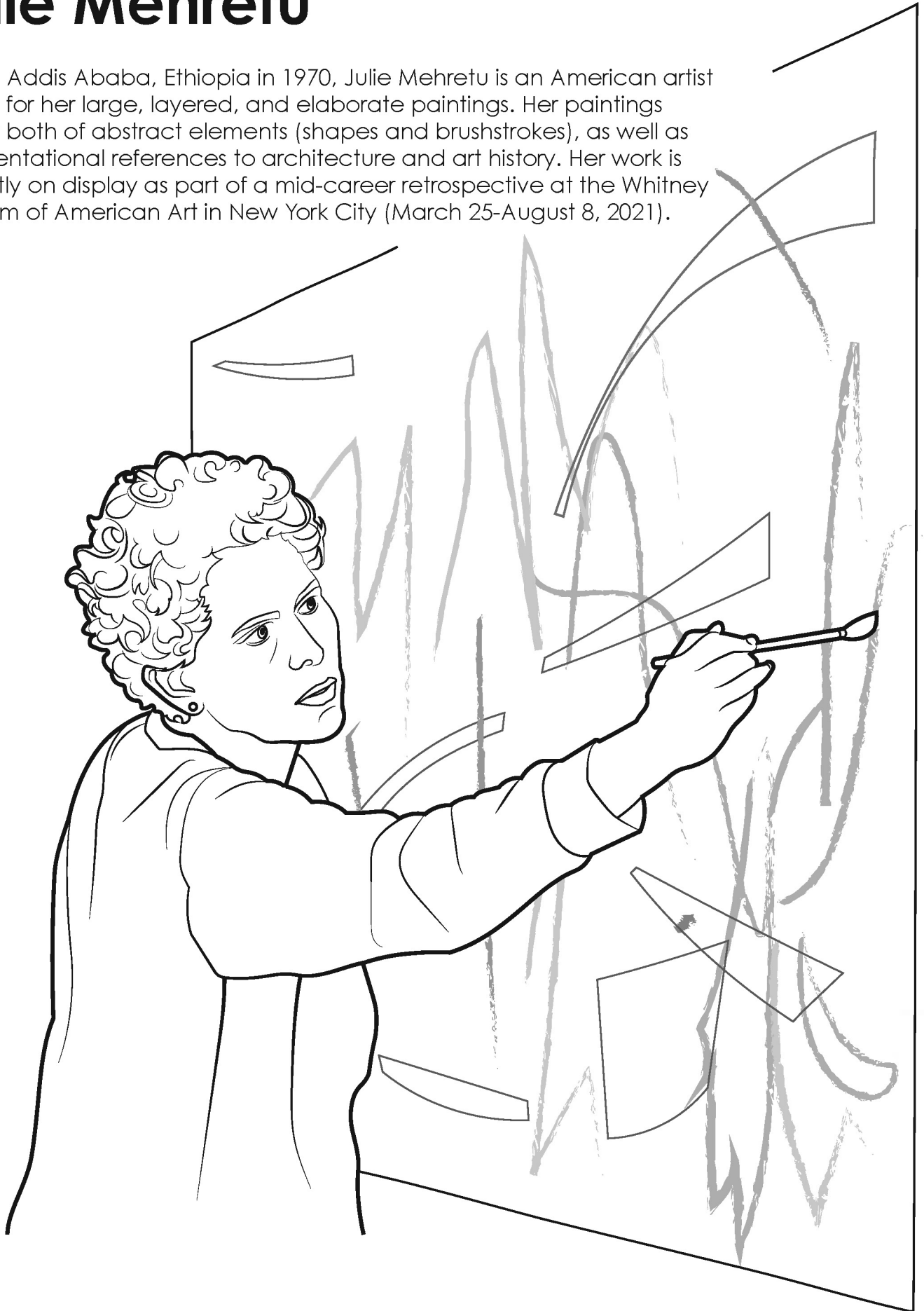

Julie Mehretu uses **additive** and **subtractive** processes in her paintings.

An **additive** process means to create lines, shapes, or forms by adding material to the composition. A **subtractive** process means to create lines, shapes, or forms by removing material from the composition.

In the following exercise, learn how to use simple additive and subtractive processes in your own drawings.

You will need:

- graphite pencil**
- eraser**

**1**

In the first box, draw a shape by adding marks from your pencil. This is an additive drawing.

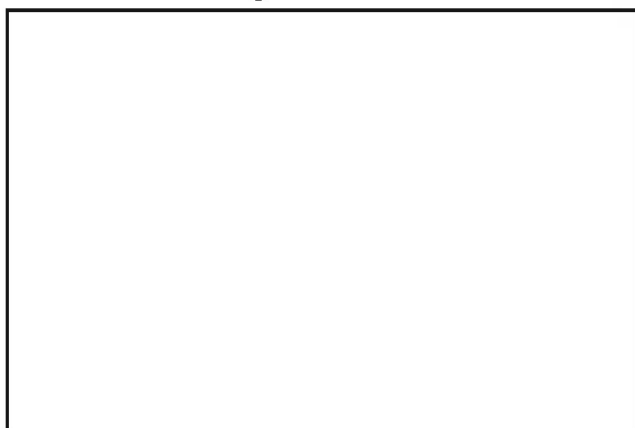

**2**

Now, color in this entire box with pencil. Then, use your eraser to create the same shape you made in the first box by erasing the graphite of the pencil from the box. This is a subtractive drawing.



**3**

In the third box, combine your additive and subtractive processes to create a unique and complex composition, just like Julie Mehretu!

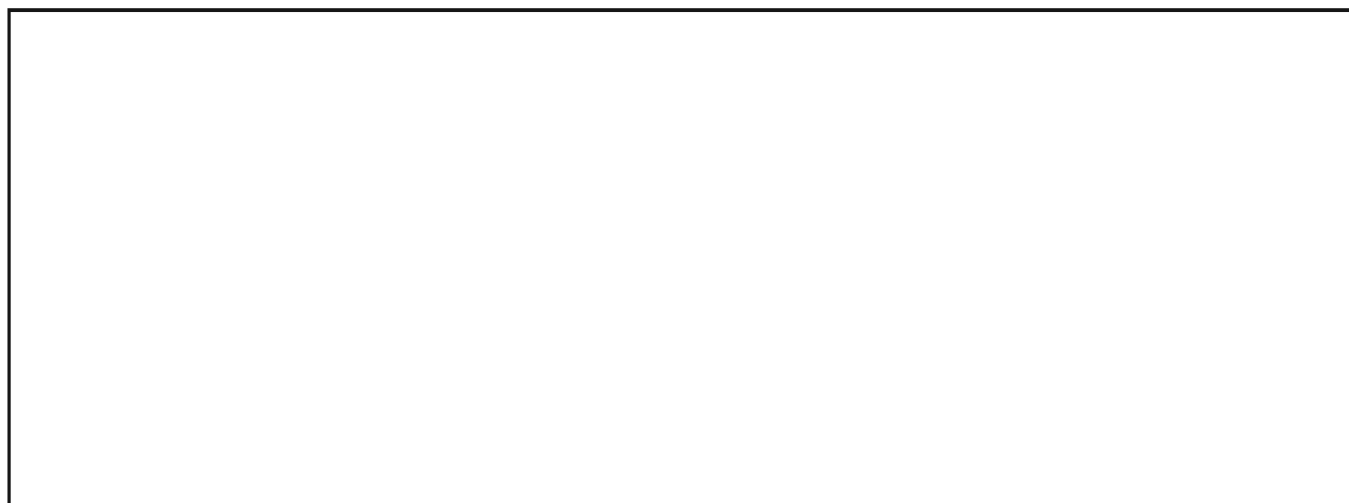

# Catherine Opie

Born in Sandusky, Ohio in 1961, Catherine Opie is an American photographer known for her portraits of queer people, subcultures, communities, and the broader American cultural landscape. Identifying as a lesbian woman, she also portrays herself through self-portraits exploring her own relationship to gender, sexuality, and family. She is currently a professor at University of California at Los Angeles (UCLA).



Some of Catherine Opie's most famous work includes photographs she took of herself, also known as **self-portraits**. Have you ever taken a photo of yourself, or drawn a picture of yourself? In the space below, create your own self-portrait. Use a mirror to draw yourself from life, or create a self-portrait from imagination.

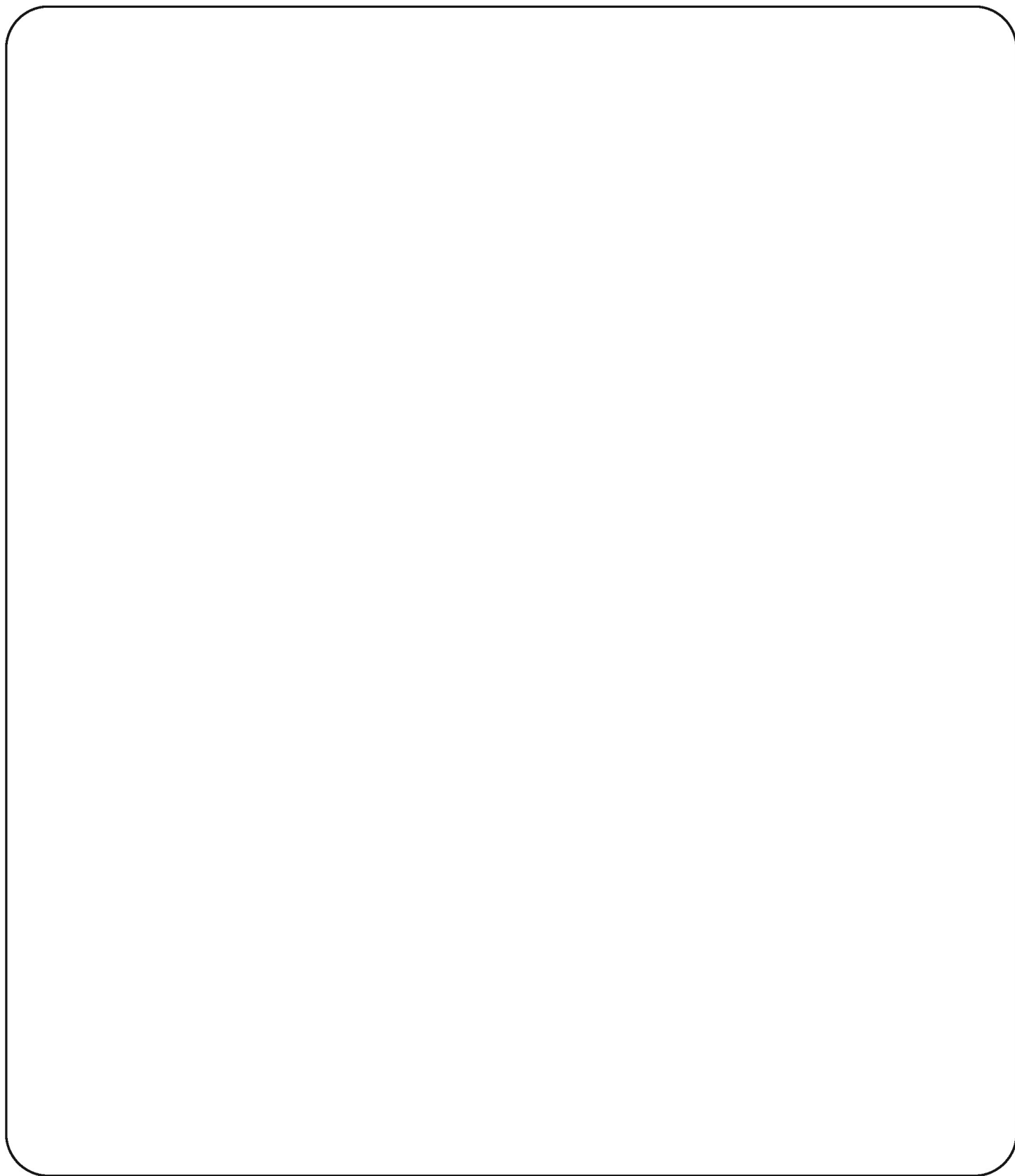

# Sylvester

Sylvester is a gay disco icon. He set the scene for many artists following. Sylvester never felt the need to be identified or boxed into a label, he was just Sylvester. His top hit, *You Make Me Feel (Mighty Real)*, talks about how hitting the dancefloor, feeling the heat while dancing with somebody, and moving to the disco rhythm make you feel even more real. The disco scene was meant to celebrate all people who are different. Uniting together by love and their moves on the dance floor.



**“I am Sylvester, I am proud of who I am”**



# Paper Doll

1. Using scissors, cut out the paper doll with the base, and the stand. Cut along the dotted line on the base and on the stand. Fold the stand in half, along the solid line.
2. Attach the stand on to the base of the doll.
3. With the clothing stencils provided, design whatever kind of clothing you want.
4. After designing your clothing, cut them out along with the tabs and paste them onto your paper doll.
5. Mix and match how you like!



# Chavela Vargas

Chavela Vargas was a Costa Rican born Mexican singer. She sang rancheras, songs about the heart and its sorrows. Even though it was a traditionally male dominated music scene, Vargas broke all barriers. Despite pressures from those around her, Vargas never changed the pronouns in her songs and sang about loving women long before she officially came out.

Chavela was a person who knew who she was. What was on the inside and what she could give, she wore it on her sleeve. In order to achieve that type of certainty with yourself, you have to get to know and love who you are on the inside.

Rancheras is a music genre that originated in Mexico. Its themes include life's passions and sorrows. The songs are usually about love, failed love, national pride, and nature.

Color in the image of Chavela Vargas below!



# Chavela Vargas Significance Box

Chavela was a person who knew who she was. What was on the inside and what she could give, she wore it on her sleeve. In order to achieve that type of certainty with yourself, you have to get to know and love who you are on the inside.

Decorate the inside of the box with aspects of yourself that only you know, or that you protect very well. These can be things that you might not be ready to share or talk about. They can be drawings, written notes, or small physical objects. Then, decorate the outside of the box with aspects of yourself that you love to show off.

Cut along the outer outline (solid lines) of the image below. Fold along the dotted lines. Glue the tabs on each side to make your box! Note: The "tab" on the far right side of the box is a flap to help open and close the box.

If you feel comfortable, show your peers what is on the inside of the box, they can look but not ask questions. If there is something in the box that you are ready to show, pin it to your clothes and show to your peers. Ask each other questions about the things that you wear on your sleeve.

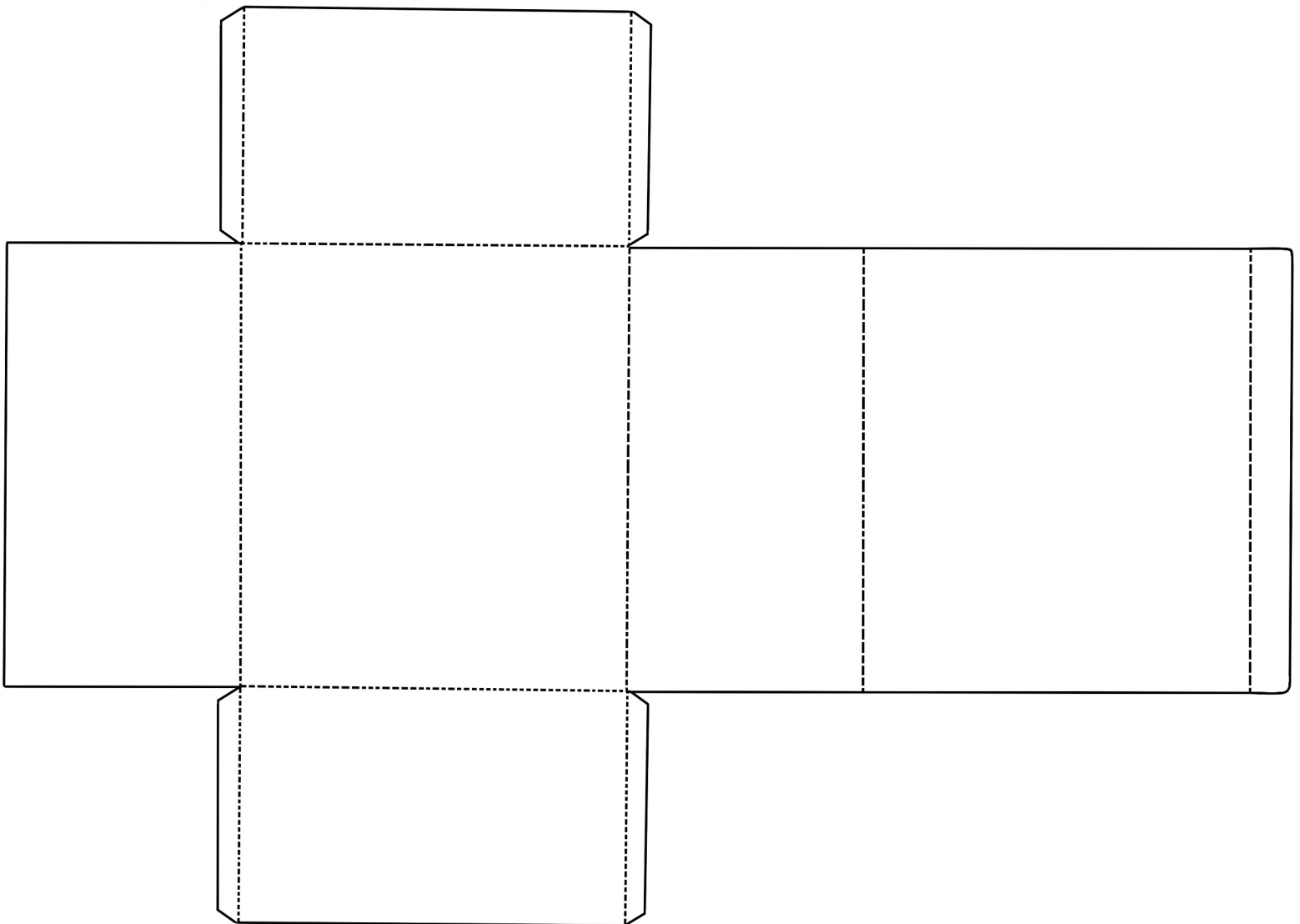

# Mickalene Thomas

You will be making a 3D self-portrait in a room that you create! Start by making a small 3D space out of paper.

You can do this by taking 3 blank pieces of paper. Place one flat on your table and tape another piece of paper so it stands vertically on the edge of your first one. Tape the last piece of paper on one of the adjacent edges so that it stands up as well and you've created your 3D space!

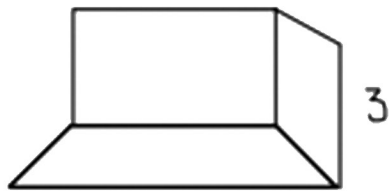
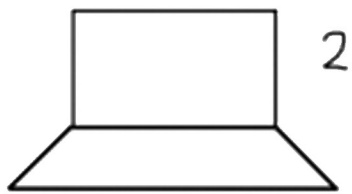
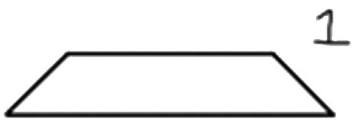

Here are some textures you may want to use in your portrait.

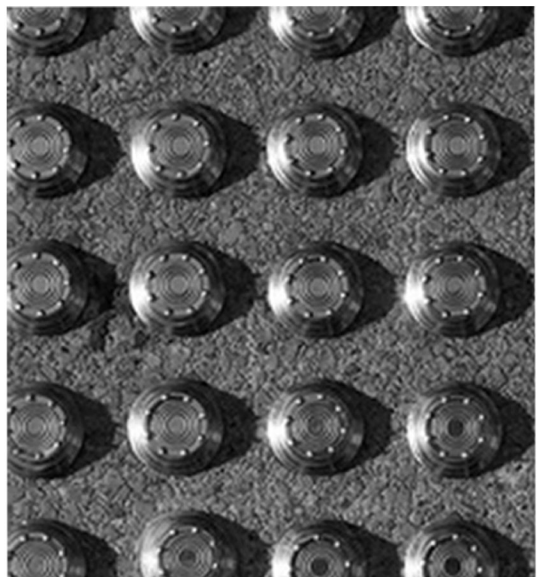
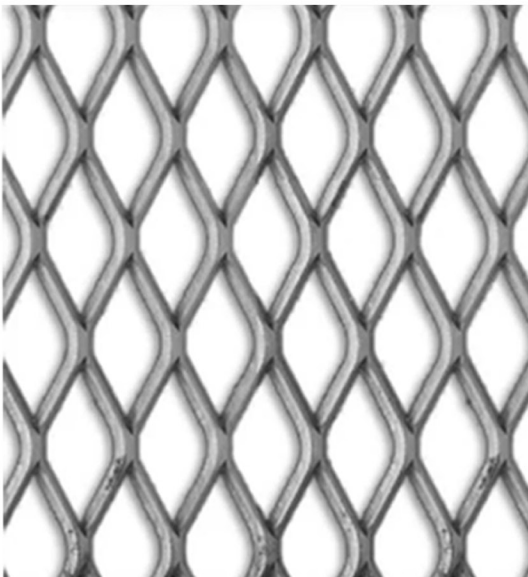
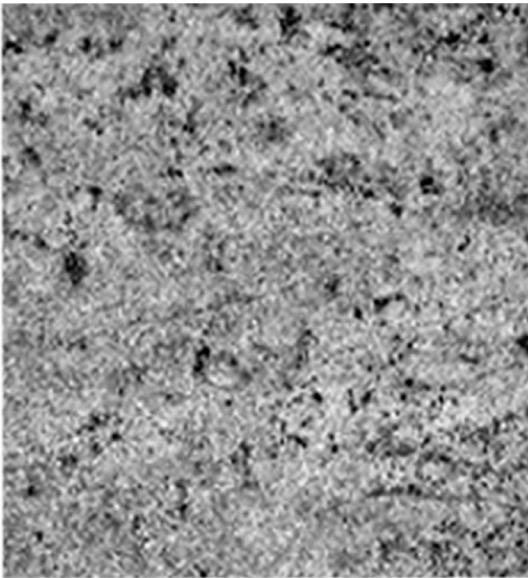

# Paul Mpagi Sepuya

Paul Mpagi Sepuya (b. 1982) is an artist and photographer based in Los Angeles and New York. His work explores the depiction of the human body in portrait photography. He creates intimate, strange, and ethereal moments by simplistically pairing his subjects with objects like mirrors and pedestals, and captures these compositions through his camera lens in his studio. His work was recently featured in the 2019 Whitney Biennial and can be seen in the permanent collection of the MoMA.



Paul Mpagi Sepuya's noted for his use of large mirror shards in his portraits, which reflectively capture cropped and incomplete portions of the human body. We see ourselves a lot in mirrors, but it is usually a complete picture of us. Below, you will see a shattered mirror. Can you use the mirror to study the different fragments of your own body? In each of the pieces of the mirror, draw a parts of your body you can see in your reflection of a real mirror.

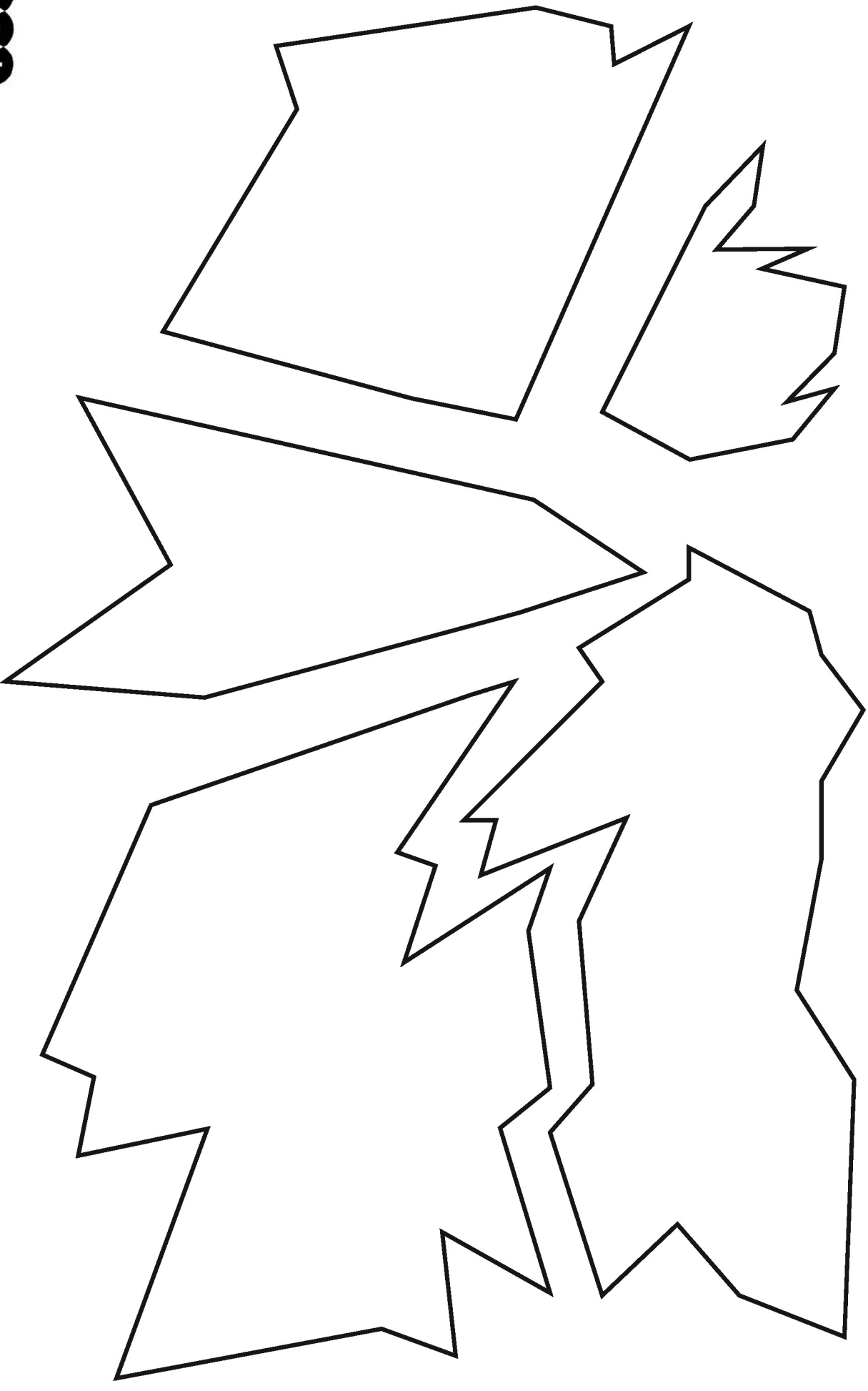

# Harmony Hammond

Harmony Hammond is an American artist known for her foundational work within the feminist art movement of the 1970s. In 1972, she co-founded the A.I.R. Gallery in New York, one of the first women's cooperative art spaces in the city. While also a painter and sculptor, she is most well known for exploration of craft practices traditionally conceived of as feminine, such as weaving. Depicted below is a representation of one of her works from the famous series **Floorpieces**: a woven floor sculpture invoking the rustic craft of rug weaving, made from discarded fabric found in the dumpsters of New York's garment district.

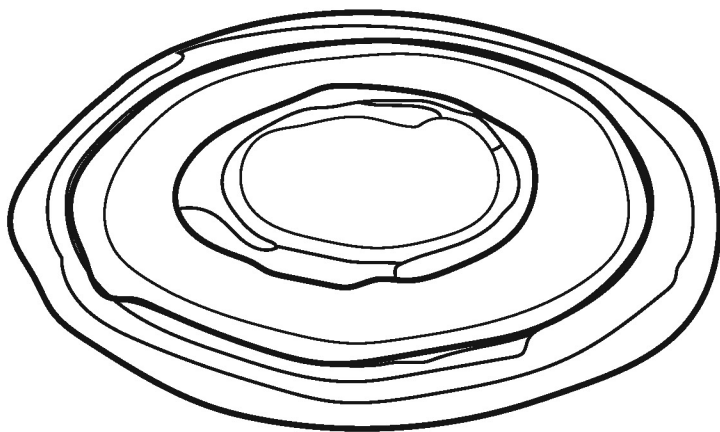
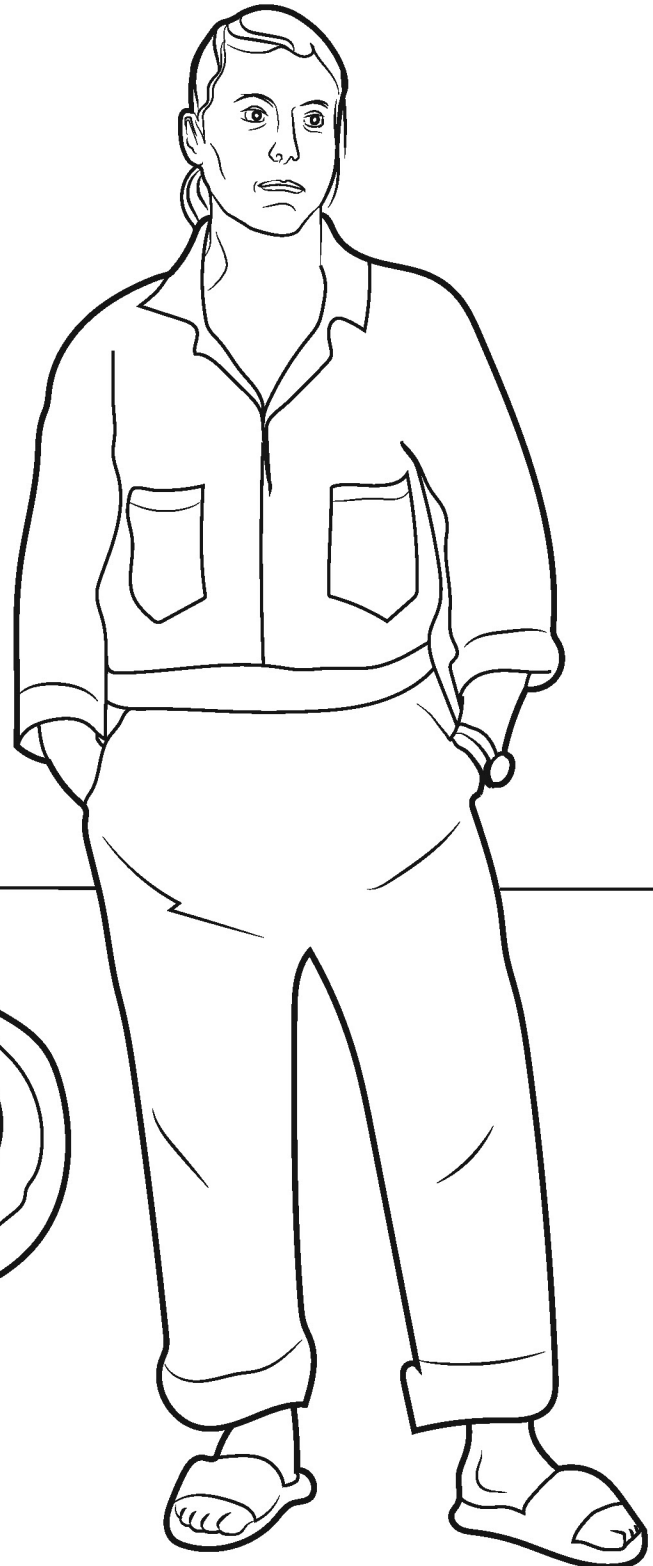
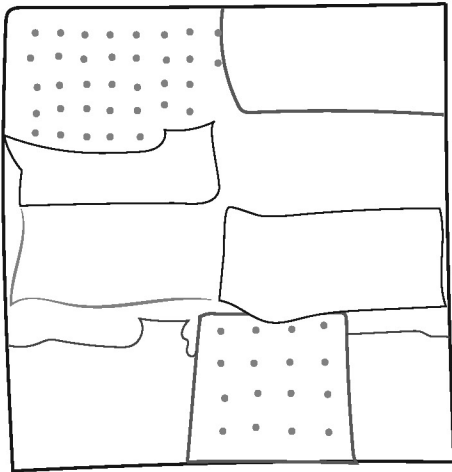



After exploring some of the color relationships in Harmony Hammond's **Floorpieces**, think about what colors you would incorporate in a braided rug of your own design. In anticipation of creating your own rug, brainstorm ideas by coloring in this blueprint of a Hammond floorpiece below.

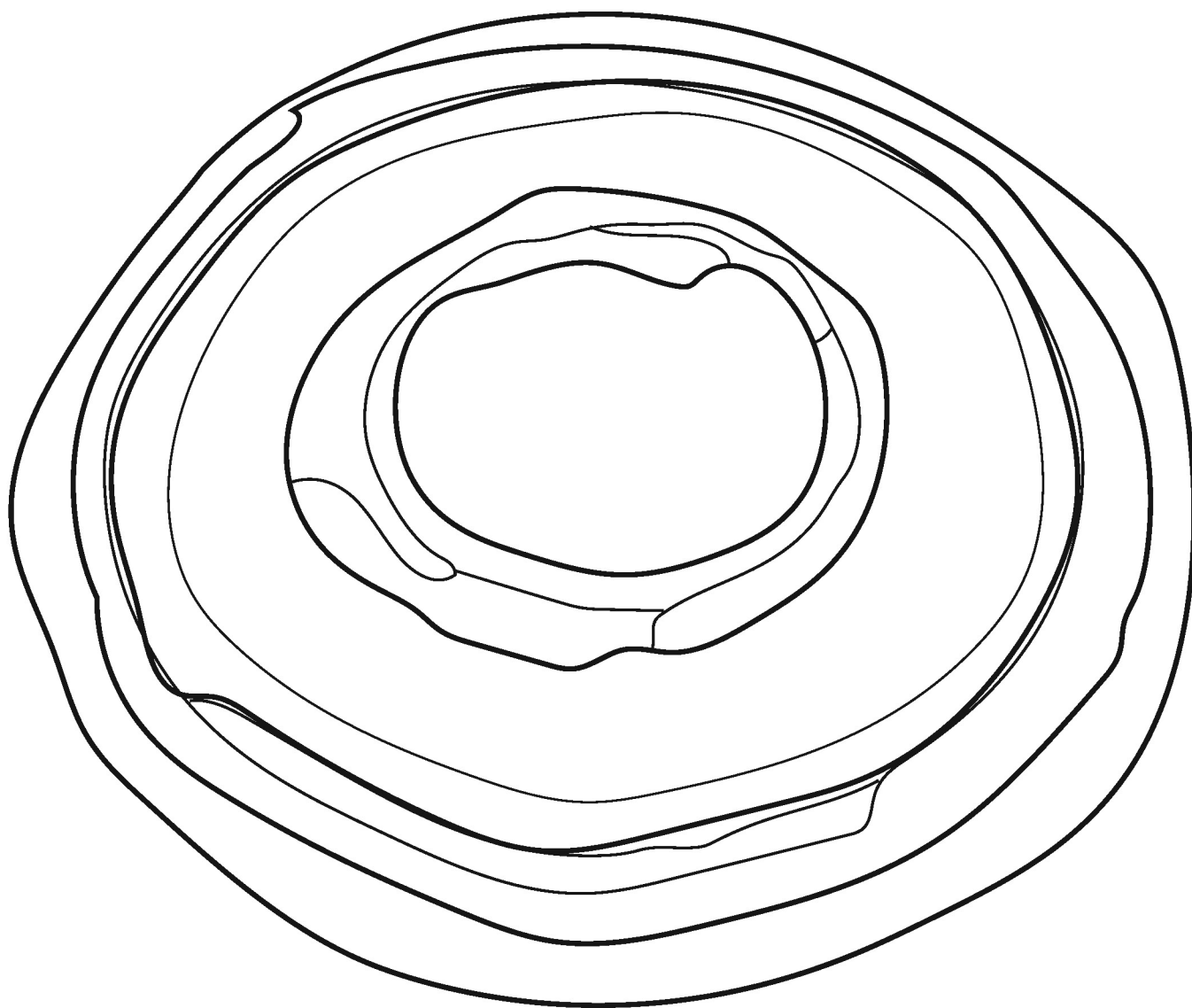

# Shanel Edwards

"a dance floor be romance, resistance, and refuge"

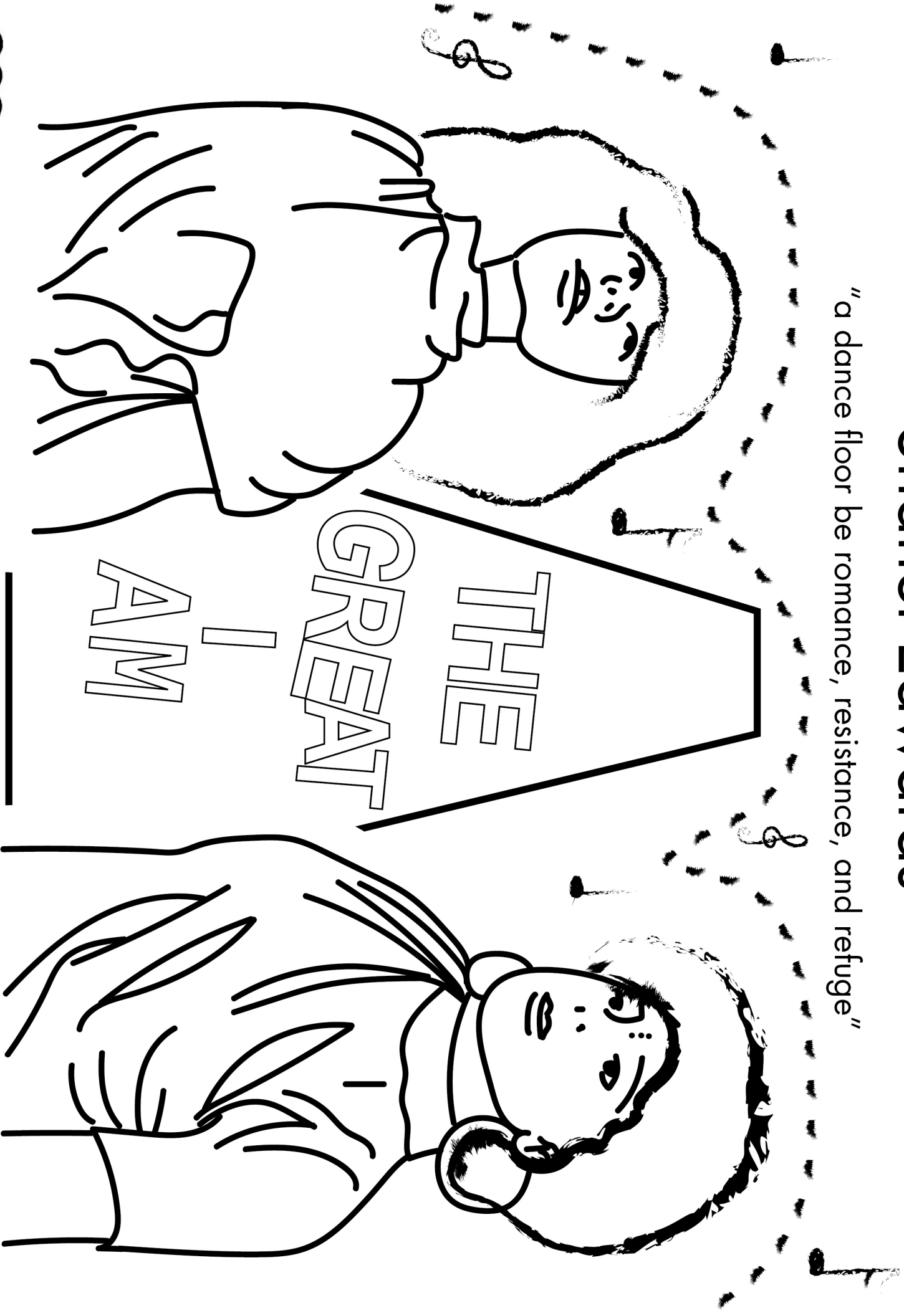

# Hilda Doolittle on Imagist Poetry

1.

Draw a place that inspires you and makes you feel free in the box below.

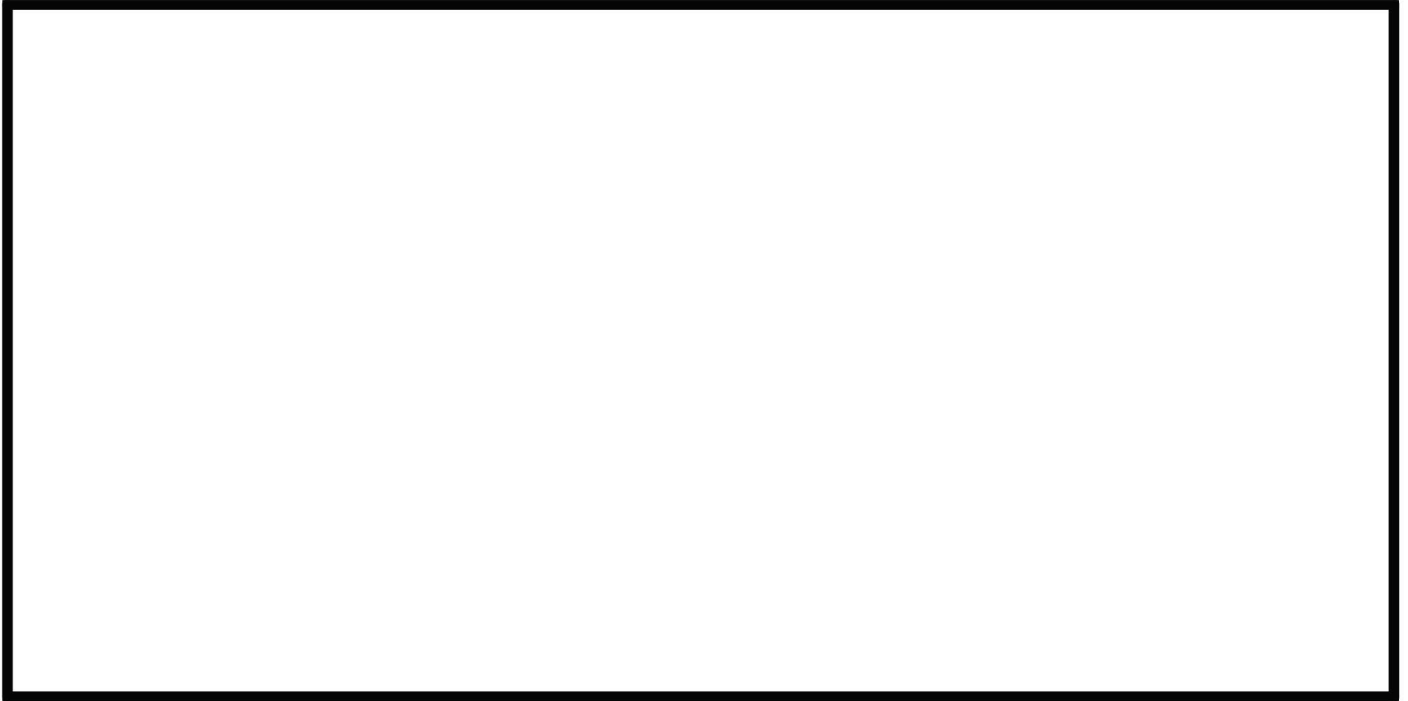

2a.

Write some adjectives for how you're feeling now.

2b.

Write some adjectives for how the place you drew makes you feel.

3.

Use the adjectives from Step 2 to compose your poem.

# RIVERS SOLOMON ON INSPIRED WRITING

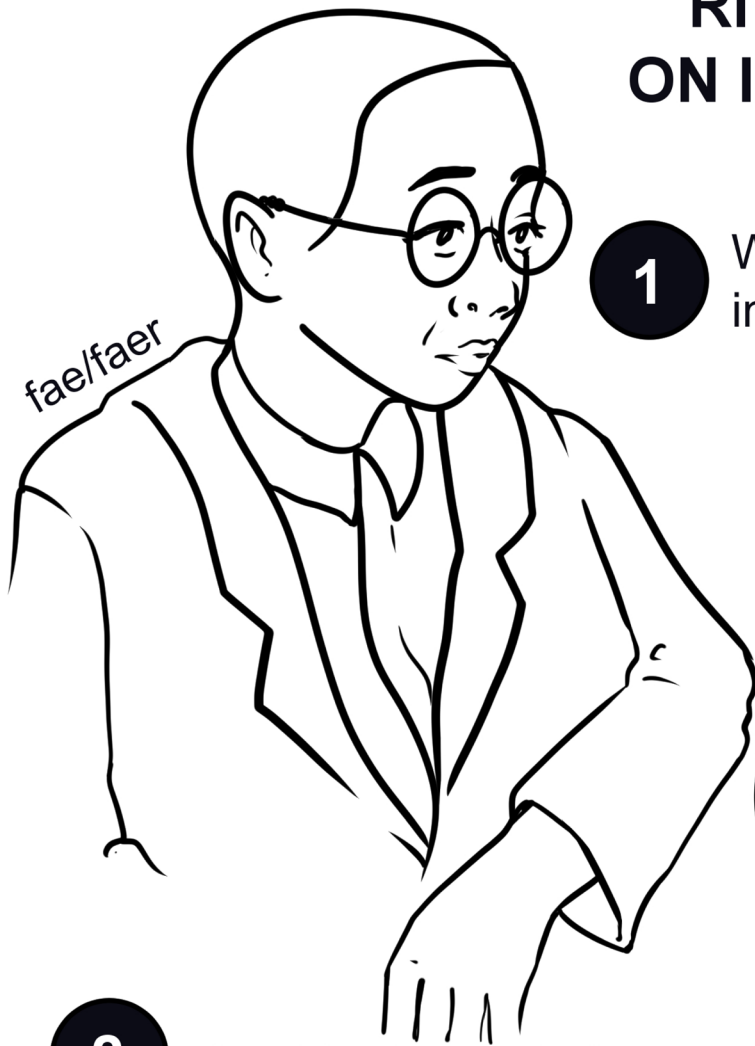

**1** Write out some of your ideas in the thought bubble below.

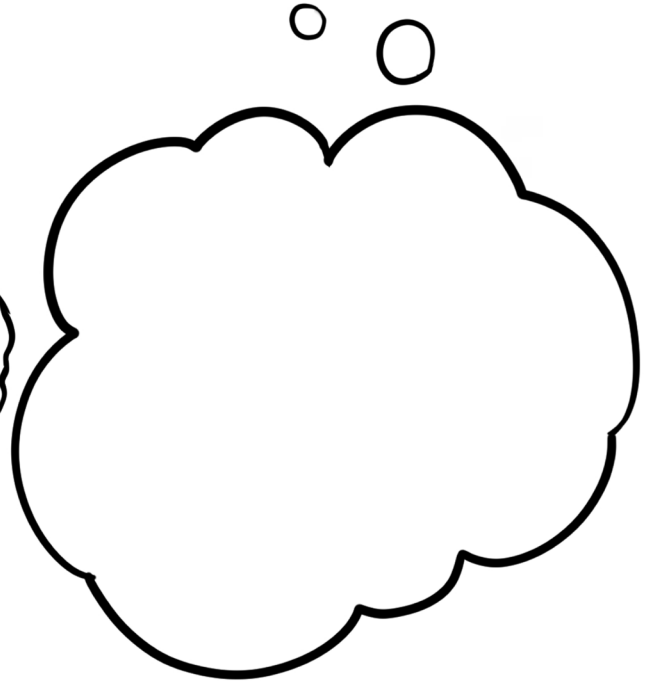

**2** Now it's time to build your storyboard outline!

## Scene List

1. \_\_\_\_\_
2. \_\_\_\_\_
3. \_\_\_\_\_
4. \_\_\_\_\_
5. \_\_\_\_\_
6. \_\_\_\_\_



# Laetitia Ky

Laetitia Ky is an Ivorian Coast model and artist who uses her hair and wire to make hair sculpture pieces carrying a message. She uses her platform to open conversation about topics that are considered taboo, unfair, or that goes against human rights. She also uses it to spread information and show solidarity.

Laetitia is an advocate for empowering yourself and those around you who are in need of empowering themselves too. Think about how we can embody, embrace and empower these taboos. How can we promote self-love?

Brainstorm and design the type of wire art that you want to create on Laetitia's head. Then, create your own wire art with yarn, fabric, and any other wrap-able materials.

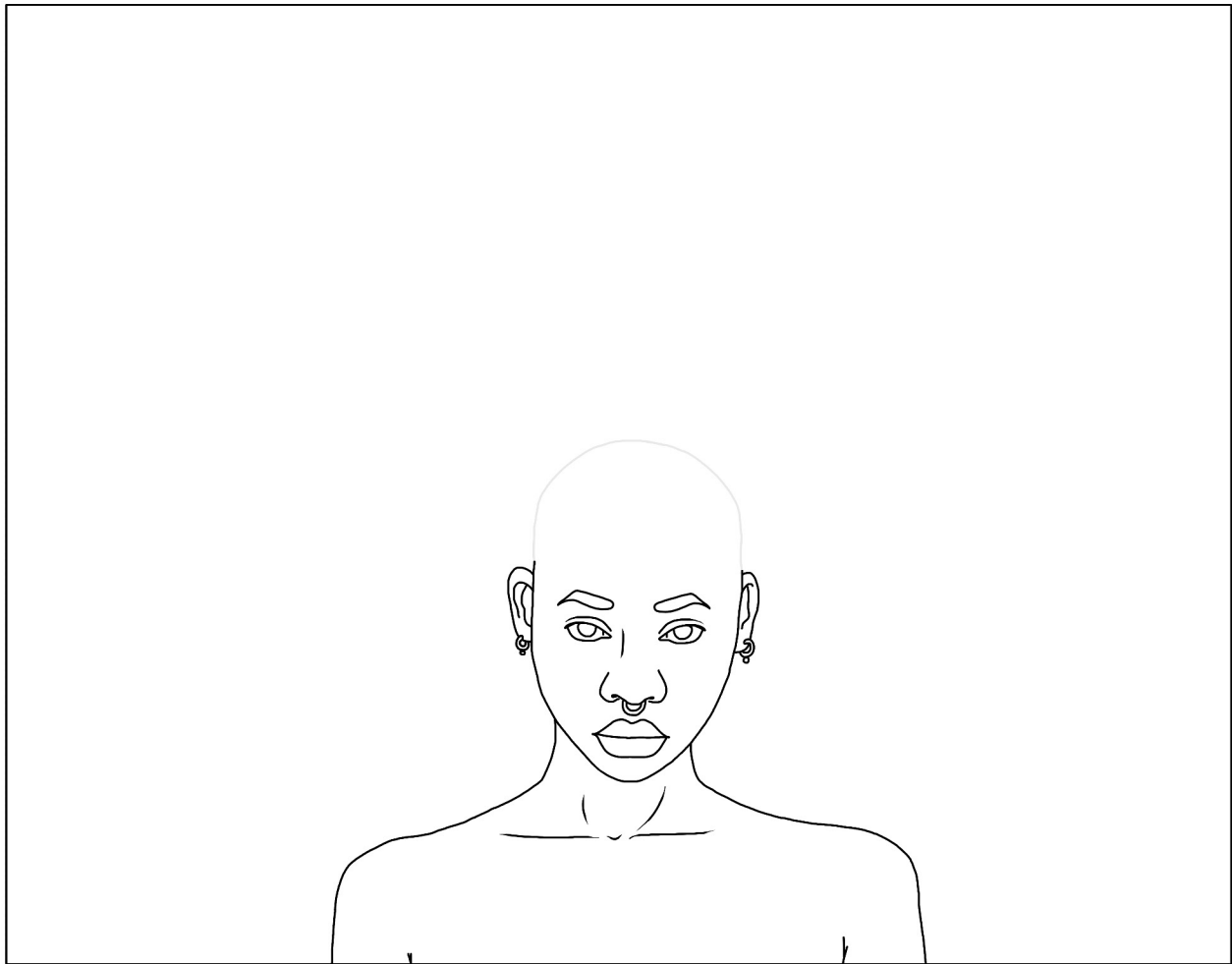

## Wire Hair Art Project

- Step #1 Design the idea you want to create and the message you want to convey in the box.
- Step #2 Mold the wire into a shape representing your idea.
- Step #3 Make a knot with the yarn at one end of the wire .
- Step #4 Wrap the yarn around the wire and keep pushing the yarn back to resemble hair.
- Step #5 Make sure your wire is tightly wrapped and leaves no space between.

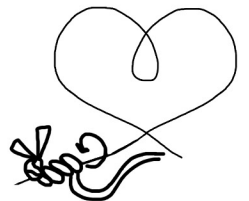

**WHY BE RACIST,  
SEXIST,  
HOMOPHOBIC, OR  
TRANSPHOBIC WHEN  
YOU COULD JUST BE  
QUIET?**

# Emerald City

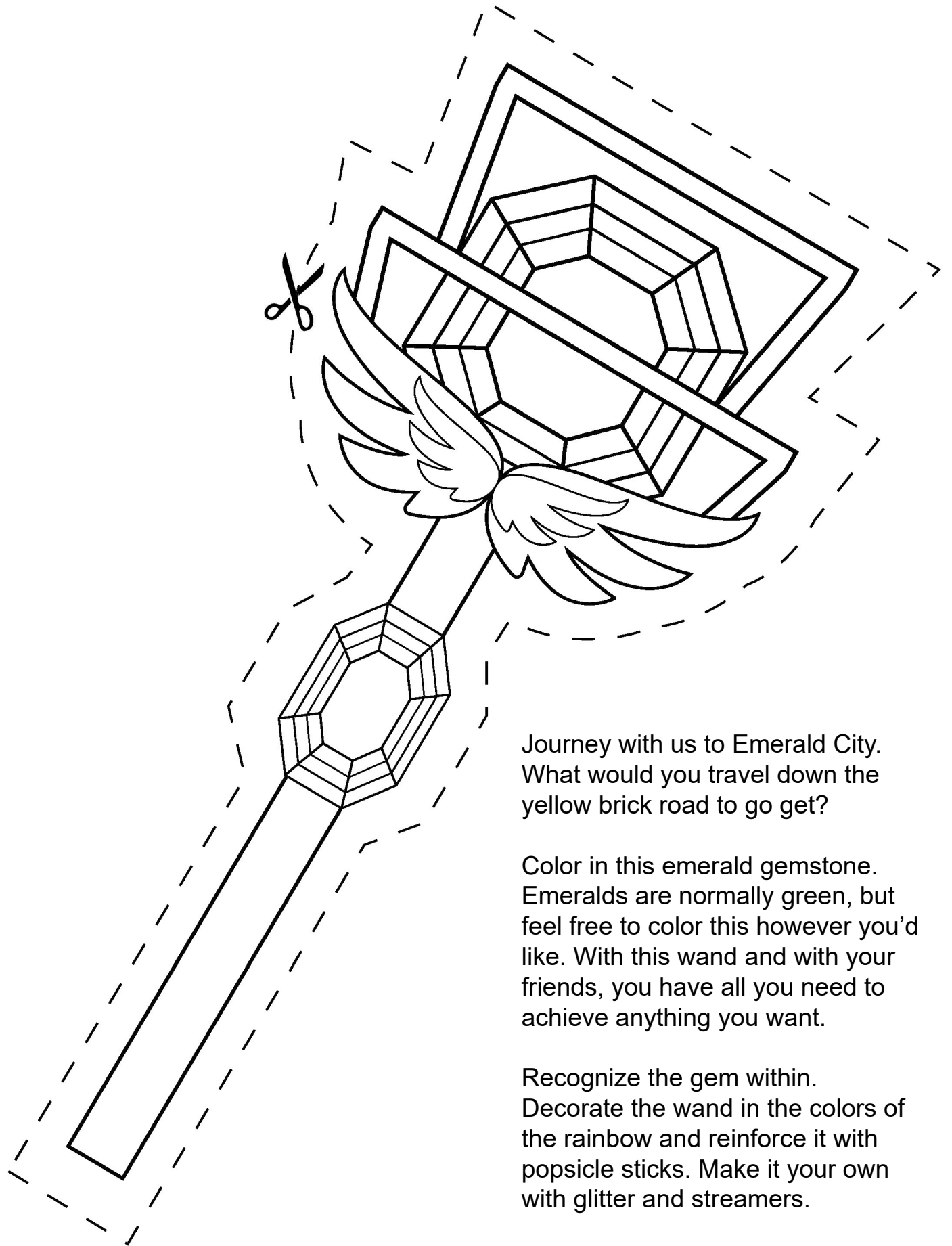

Journey with us to Emerald City. What would you travel down the yellow brick road to go get?

Color in this emerald gemstone. Emeralds are normally green, but feel free to color this however you'd like. With this wand and with your friends, you have all you need to achieve anything you want.

Recognize the gem within. Decorate the wand in the colors of the rainbow and reinforce it with popsicle sticks. Make it your own with glitter and streamers.



# Share The Love

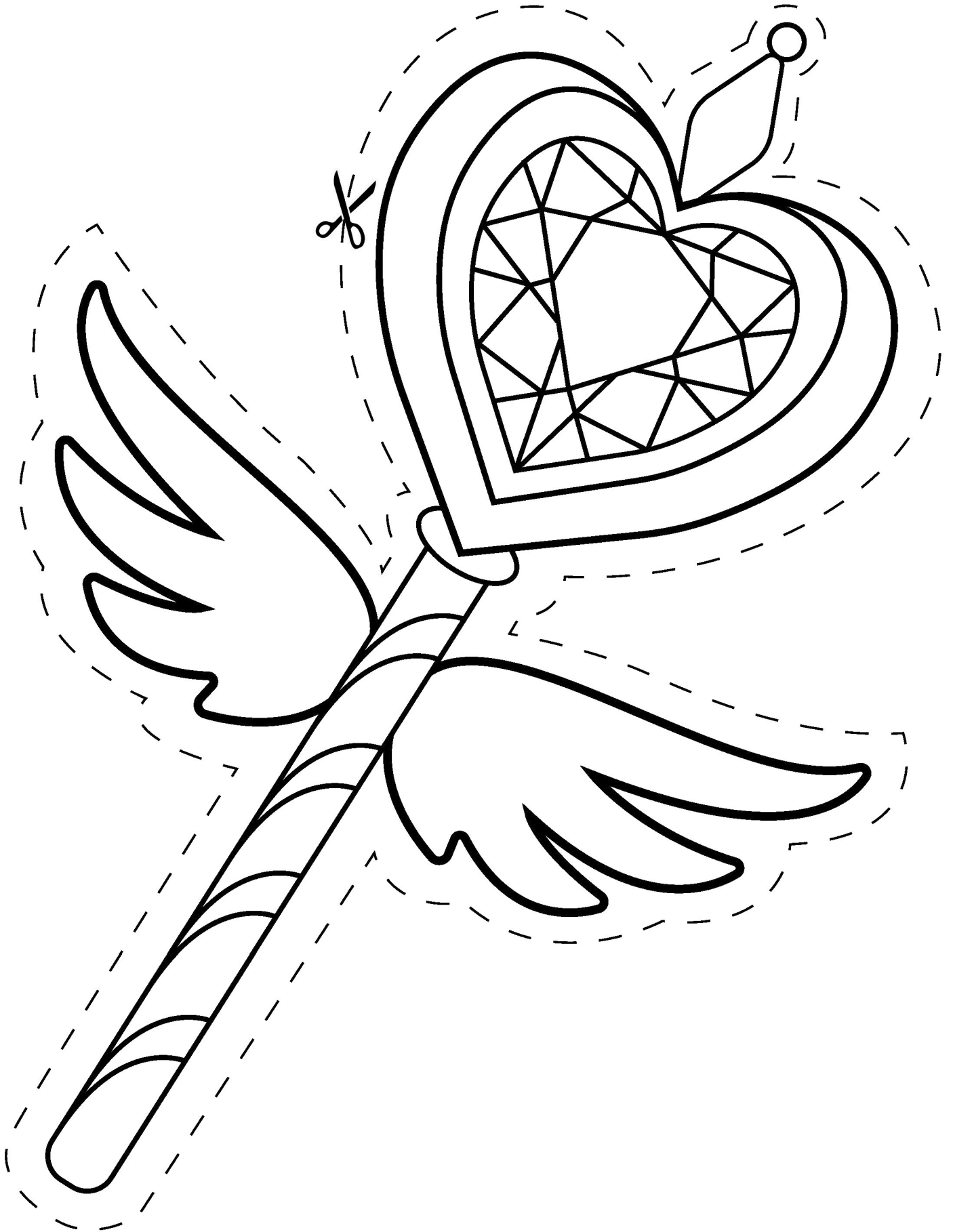

# Crown

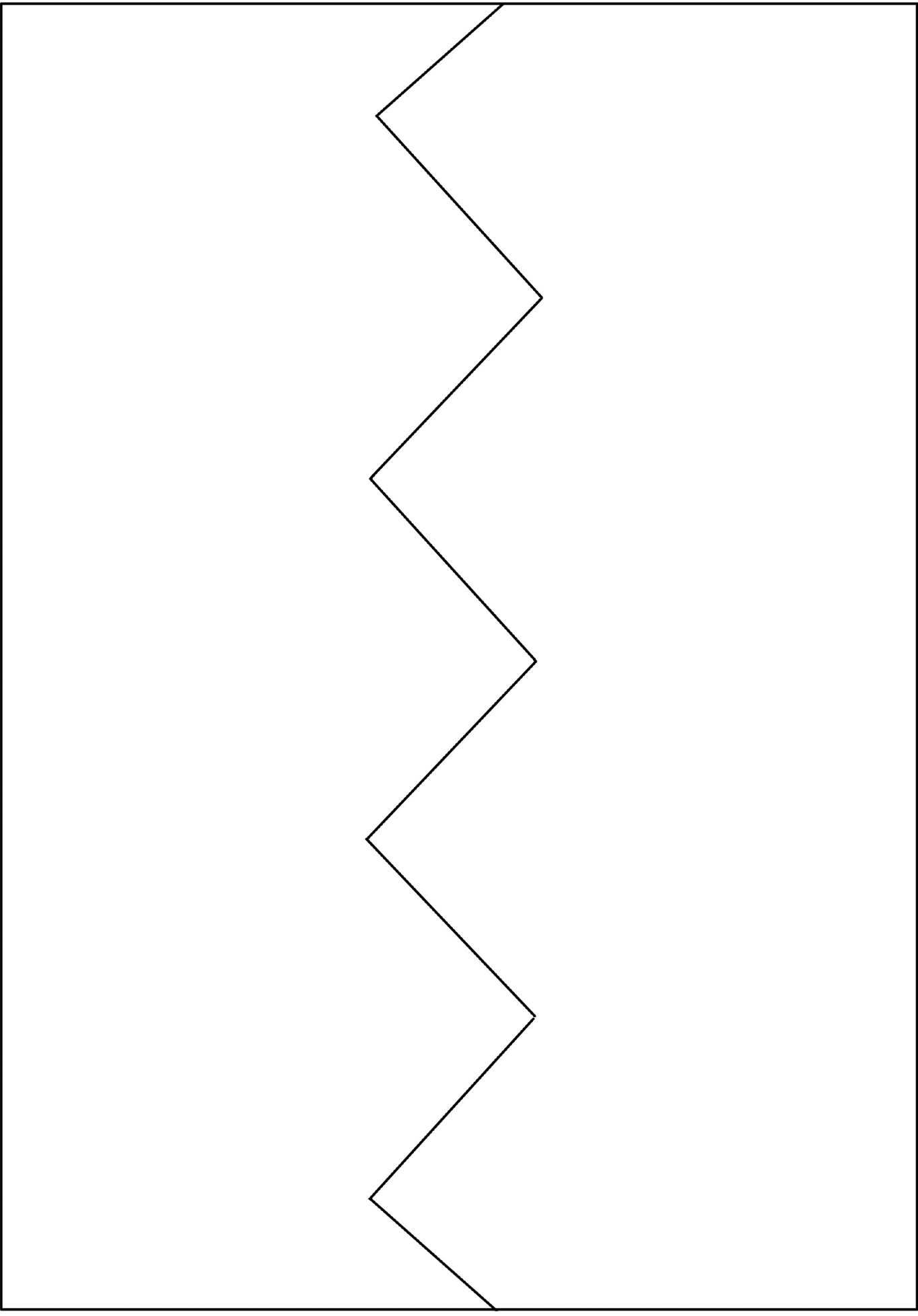

**Cut out and decorate! Then tape the crown together!**

In the same way that you might nurture a garden, how do you grow your pride? Decorate this handout with all the ways you grow your pride and think of a space you could put this up. Is there a local café with a bulletin board that you can post this at? Any shop you can ask to put this in their window? Encourage going green in our community while celebrating pride in our LGBT+ youth!

GROW

PRIDE



---

# Grows Pridel!

**as i** <https://artsphere.org/landing-page-lgbt> Seeds for Philly Gardens



---

# Grows Pridel!

**as i** <https://artsphere.org/landing-page-lgbt> Seeds for Philly Gardens



---

# Grows Pridel!

**as i** <https://artsphere.org/landing-page-lgbt> Seeds for Philly Gardens



---

# Grows Pridel!

**as i** <https://artsphere.org/landing-page-lgbt> Seeds for Philly Gardens

# Black Out Poetry: Express Yourself!

Black out poetry is a type of poetry that lets you express yourself using pre-written text!

Start by printing out a block of text from anywhere (an article, a recipe, an essay, it can be from anywhere!)

After printing out your text, take a black marker or pen and start to cross out words that you don't want in your poem and keep the words that speak to you.

Slowly, you will end up with a bunch of words that you can use to express yourself. These words don't have to make sentences but they should be important to you.

Use this technique to help express yourself and who you are! Have fun with it and be as creative as possible!

Here are some blocks of text that you can use to get started.

Nothing happens – the march of darkness halts at the door to the house, and all the clamour of fading falls silent, makes a thick skin like on hot milk cooling. The contours of the buildings against the backdrop of the sky stretch out into infinity, slowly lose their sharp angles, corners, edges. The dimming light takes the air with it – there's nothing left to breathe. Now the dark soaks into my skin. Sounds have curled up inside themselves, withdrawn their snail's eyes; the orchestra of the world has departed, vanishing into the park.

Excerpt from *Flights* by Olga Tokarczuk

She likes how the lattice provides a touch of fantasy. Public buildings have been changing in the past few years, just as private houses have. The relentless, charmless look – the only one permitted in her youth – has disappeared. Here she parks in front of a bright dome that has a look of welcome, of cheerful excess. Some people would find it fakey, she supposes, but isn't it the very thing you would want? All that glass must cheer the spirits of the old people, or even, perhaps, of some people not so old but just off kilter.

Excerpt from *In Sight of the Lake* by Alice Munro

# Keystone Architectural Symbol

A keystone (or a capstone) is a wedge-shaped stone at the top of a masonry arch or a typically round-shaped one at the top of a vault. It is the final piece placed during construction and it locks all the stones into position, allowing the arch or vault to bear the weight of the stones. Because keystones are so important, they are a symbol of strength or good architecture and are often placed at the top of doors, windows, and recesses.

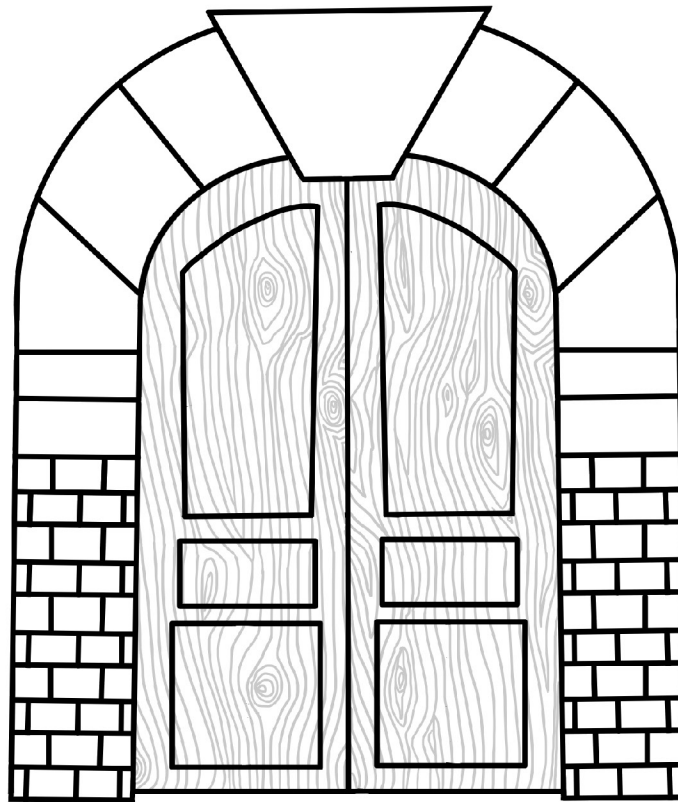

What are your strengths? What doors do you need to walk through to take you to the next leg of your journey? What are some obstacles you need a door to help guide you through? How will you build on your strengths and make the world a better place? Color, cut, and add words or a collage on the wall, decorate the doors and illustrate what you hope to find behind the doors as an affirmation of who you are and where you want to be.

# Keystone State Symbol

The keystone is the official symbol of the Pennsylvania state government, chosen based on its shape on the U.S.A.'s map. Did you know that every Pennsylvania state agency has its own variation of the keystone as its logo?

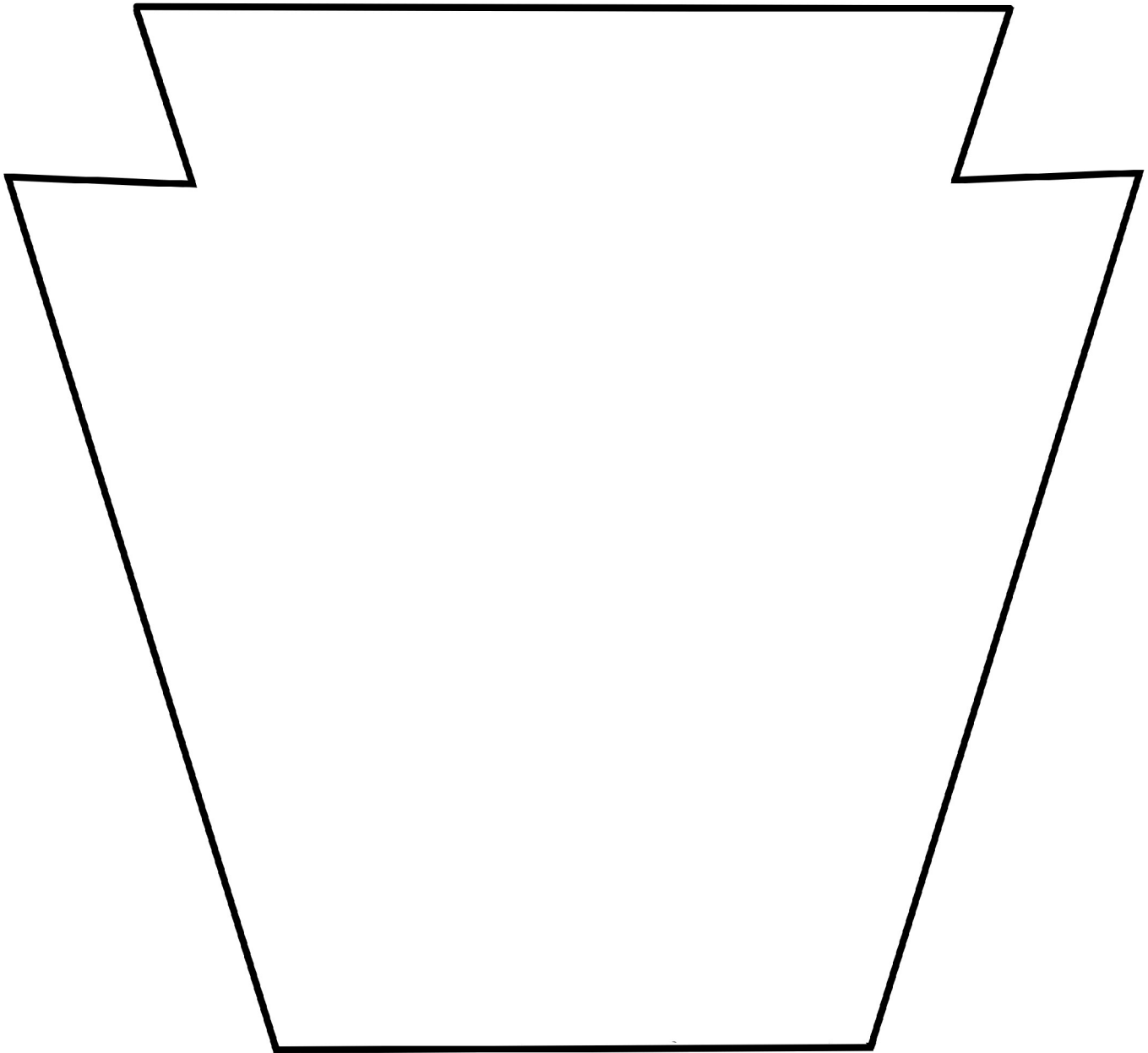

How can the State of Pennsylvania better represent you and what you value? What contributions do you make to this state that you want others to recognize? Add your drawings, words, and ideas inside and personalize your keystone, which is also a symbol of strength.

# FREE COMIC BOOK DAY

Celebrate Free Comic Book Day by drawing your own comic in the panels below!

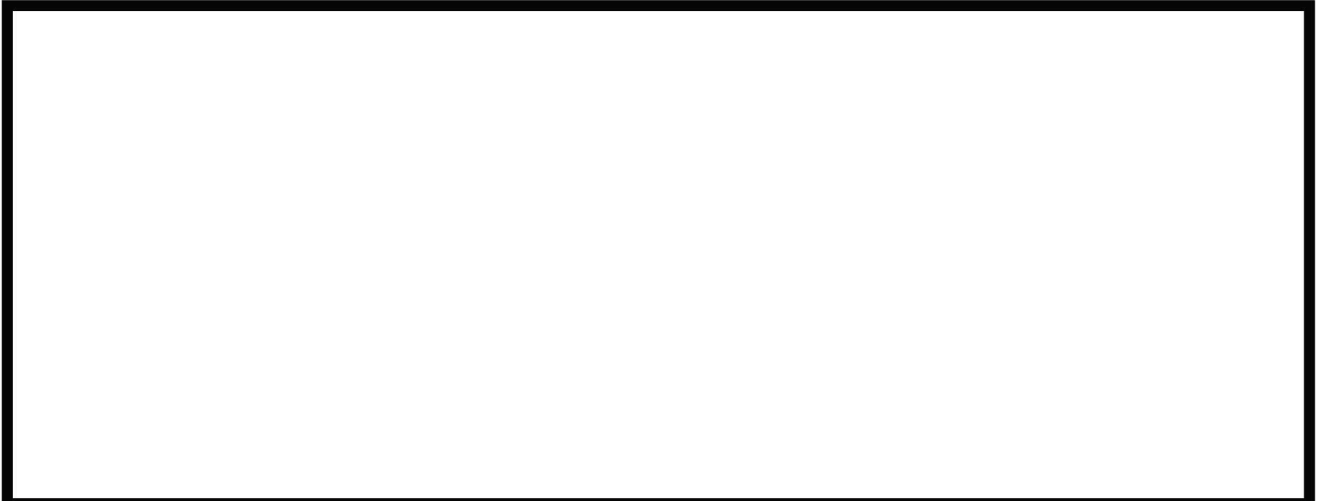
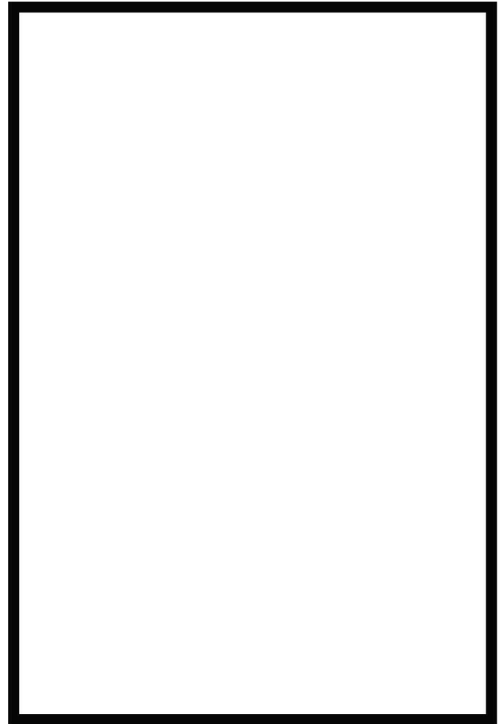



# Diorama Making

Materials: Cardboard, construction or printer paper, glue, yarn, scissors, and crayons or colored pencils. (Anything to decorate your diorama with)

Directions: Salman Toor is vulnerable in his work, and often depicts himself in his own safe spaces, like his bedroom. Create a diorama of what your safe space looks like and share it with everyone.

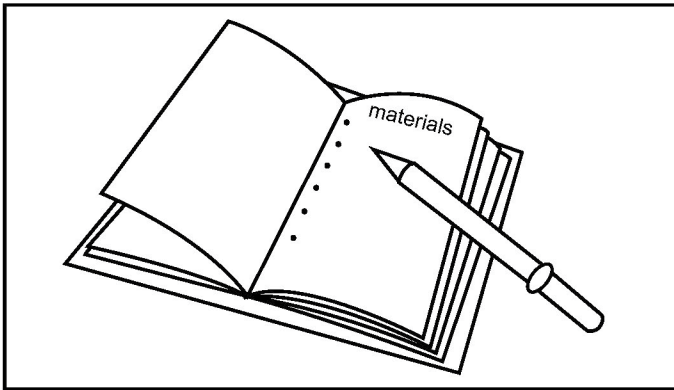

**Step 1** Brainstorm what you want your diorama to look like and what materials you'll need. Sketch out your idea and label what materials will make up what elements of the space you create.

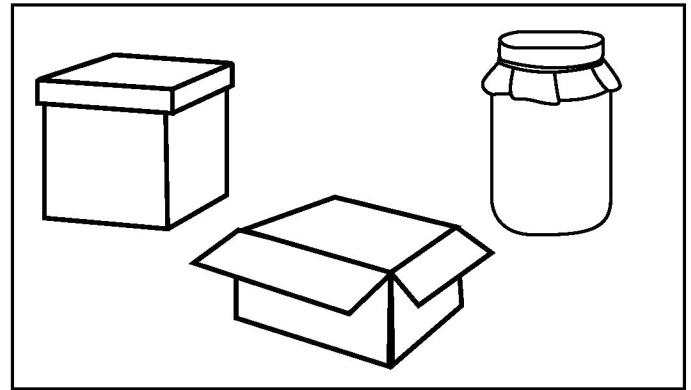

**Step 2** Your housing can be a cardboard box, jar, or anything else you can think of. You need to make the housing space a place to work out of and to be presentable, so properly clean and adjust this space as needed.

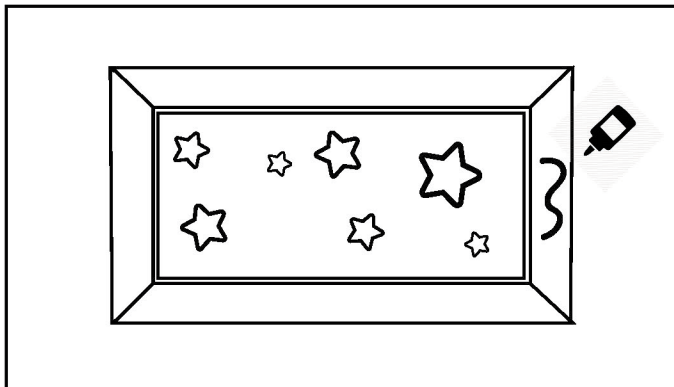

**Step 3** Line the interior or exterior of the box with paint or patterned paper to get an appealing design.

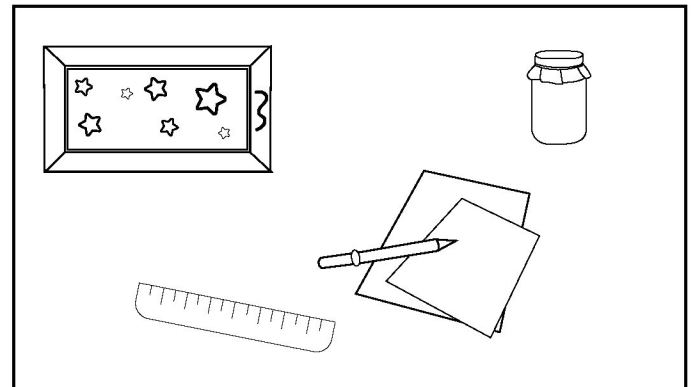

**Step 4** While allowing that to dry, start constructing the objects that will be placed within the diorama.

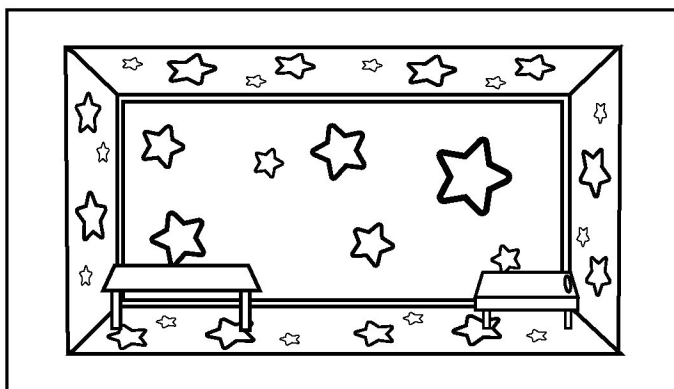

**Step 5** Once your housing is dried begin adding the decorations to your diorama and creating your space.

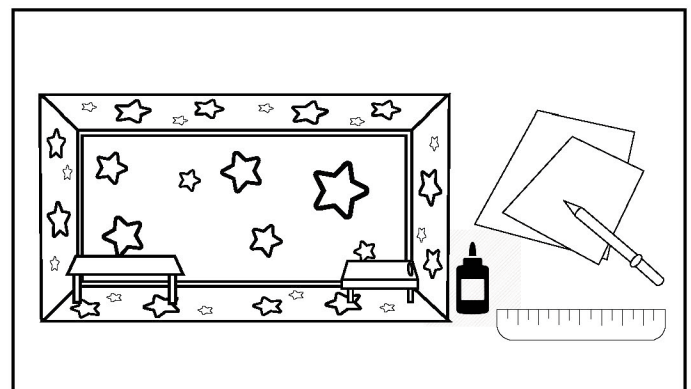

**Step 6** Finally, fine tune all of the details until the diorama looks just how you it does in your mind.

# Book of Inspiration

Materials: Cardboard, construction or printer paper, glue, yarn, scissors, hole-puncher, and crayons or colored pencils

Directions: Create a book of your biggest inspirations! Whose legacy would you like to carry on? Who inspires you to create and express yourself? Choose 3-5 artists and leaders featured on Art Sphere's interactive programs and add them to your book.

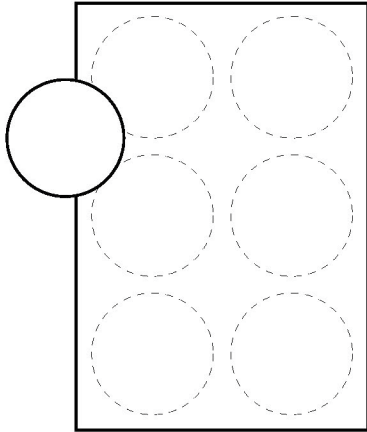

Step 1: Trace a small bowl to make 6-10 circles.

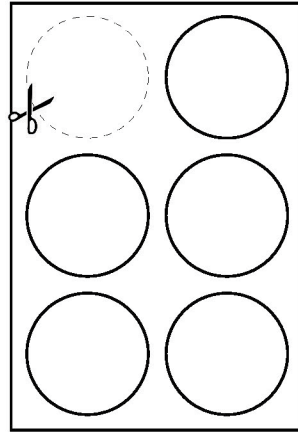

Step 2: Cut paper circles.

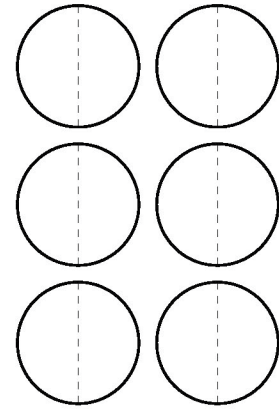

Step 3: Fold paper circles in half.

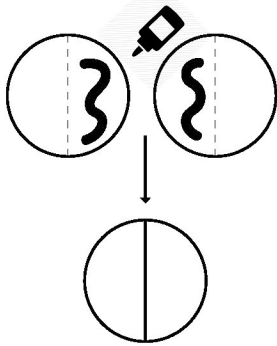

Step 4: Glue the back of right half of one circle to the back of the left half of another circle to create your pages. Repeat until all your pages are made.

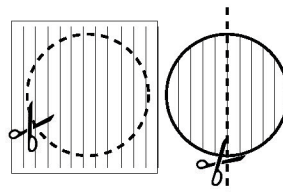

Step 5: Trace a circle onto the cardboard and cut it out. Cut that circle in half to make two semicircles

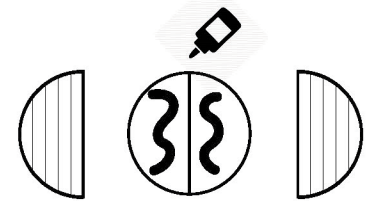

Step 6: Glue each semicircle to the front page and back page to make the covers.

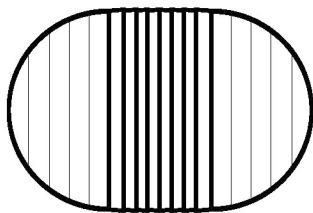

Step 7: Add stories and illustrations about your inspiring artists

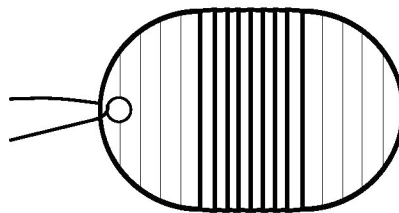

Step 8: Use a hole-puncher to add a hole to the front cover and tie yarn through it.

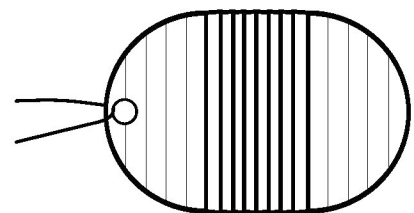

Step 9: Go create with your new book of inspiration!